

PRODUCT GUIDE

Marine commercial engines, options and accessories





THIS IS VOLVO PENTA

Volvo Penta is a world-leading supplier of engines and complete power systems for marine applications. Here you will find out what Volvo Penta is all about.



HIGHLIGHTS

For us, world-class product development is a fundamental, never-ending process. These selected product highlights reflect our focus on improving the everyday boating experience.



VOLVO PENTA IPS

Superior to inboard shafts in every vital aspect – handling, onboard comfort and performance, Volvo Penta IPS has revolutionized the marine industry.



AQUAMATIC STERNDRIVE

The Volvo Penta diesel sterndrive package is second to none. Produced by Volvo Penta exclusively for marine applications, it is the most robust and reliable sterndrive package available anywhere.



MARINE AND EMERGENCY GENSET

The Volvo Penta Genset systems are the complete solution for a ship's onboard power requirements, reliable marine diesels, well-matched generators and monitoring system.



MARINE AUXILIARY ENGINE

Volvo Penta engines are renowned for their technical qualities as well as their superior reliability. No matter what your requirements are, you will find the perfect auxiliary engine in our broad range.



DIESEL INBOARD COMMERCIAL

Volvo Penta diesel technology delivers performance and reliability. Low end torque and high load acceptance allow fast acceleration and unbeaten strength for any application.



ACCESSORIES

The extensive accessories range helps builders and operators create customized installations. The genuine Volvo Penta parts and accessories ensure quality throughout the engines' lives.



PARTS AND SERVICE

With every Volvo Penta engine and drive comes one of the widest service dealer networks in the industry, present in more than 130 countries.



WANT TO KNOW MORE?

Find out where you can get even more information about Volvo Penta's wide range of products.

Find your way Use the buttons in the right-hand bar for rapid navigation in this guide. Key to the functionality of the buttons:



Back to contents page (this page).



Back to start page of the current chapter.



Next page.



Previous page.



THIS IS VOLVO PENTA

Business solutions for marine professionals

Volvo Penta is a world-leading supplier of engines and complete power systems for marine and industrial applications. As part of the Volvo Group – a world leader in diesel engine technology and one of the world's largest producers of heavy-duty diesel engines – Volvo Penta provides power solutions for marine professional customers all over the world.

We prioritize quality, safety and environmental care in all our products – from optimized drive systems to smart accessories to professional service.

Uptime and cost of ownership

We aim explicitly at creating value for you as our customer – business solutions that are profitable in the long term.

We provide fuel-efficient and reliable power systems – the very key to excellent operational economy - based on the Volvo core values, leading-edge technology and experience. Linked together in the value chain, our unbeatable power solutions, parts availability and services minimise your total cost of ownership and build your long-term profitability.

Developed, manufactured and serviced by one company

All Volvo Penta Engines are designed, manufactured, documented and fully tested in Volvo Penta factories. In Volvo Penta's marine test center, located in Sweden, advanced real-life tests are performed around the clock throughout the year.

Our core products are the Volvo Penta engines, but our offer to you goes far beyond that. Innovative drive systems and accessories, outstanding fuel efficiency and reliability, and a global service dealer network bring about a partnership for performance and profitability in the long term.

Volvo Penta gives one single contact for the whole package – engines, instruments, accessories, service, warranties etc.

Environmental leadership

Through the years, we have set an example with a number of products and solutions with an explicit environmental focus and we are continuously looking into future products and solutions. By working in close cooperation with our partners and customers, we will remain in the forefront of technological and environmental development, today, tomorrow and in the future.





Interceptor System (IS)
 The Interceptor System is integrated in the EVC platform which makes it extremely easy to handle; just push the trim assist button on the top-mount control.



Multiple Installations - Diesel Electric Propulsion

Using high-speed engines as prime movers is the most cost-efficient answer to a broad range of marine power needs. Compared with an installation based on fewer and larger engines, an installation of multiple Volvo Penta engines gives several benefits such as improved fuel efficiency, increased load-sharing capacity and better redundancy.



Volvo Penta D13-IPS900

The type approved and certified Volvo Penta IPS provides what seems to be an impossible combination: dramatically improved performance, longer operating range and, at the same time, radically reduced CO2 emissions - compared with inboard shafts and water jet propulsion.





Extended coverage

For superior cost control and protection beyond the international or national limited warranty. Read the details on how to extend your coverage in the support section.



Quadruple IPS installations

In the expanding wind farm market strict requirements are put on a wide range of parameters such as speed, efficiency and static bollard push, combined with reliability and redundancy. With crew transfer vessels within the industry growing in size and companies wanting to travel farther away from the coastline, Volvo Penta is able to offer highly efficient quadruple installations, giving added redundancy to four separate engines and drivelines.



D13 Inboard

This engine excels with its outstanding fuel efficiency and durable performance. With a unique marine torque and an impressive power-to-weight ratio its environmental impact is reduced. It is approved by all major classification societies.



QUADRUPLE IPS INSTALLATIONS

Meeting the diverse customer needs and specifications

Njord Offshore – the commercial and technical managers of a fleet of 21 m and 26 m transfer vessels – have ordered four new 26 m catamarans containing quadruple installation Volvo Penta D13-IPS900 complete propulsion systems, based on Volvo Penta marine commercial D13 engines and IPS pod units.

“Our crew vessels, and their propulsion systems, are required to meet a diverse set of parameters. We need speed, efficiency and static bollard push, combined with reliability and redundancy,” the director of Njord Offshore, Tom Mehew explains. “Evaluating our specific needs after Seawork, we found that Volvo Penta IPS came out on top. The advantages of the system’s maneuverability and dynamic positioning functionality won us over.”



Quadruples allows for larger vessels with IPS unique qualities

Volvo Penta IPS has long been a safe and secure option for customers operating in the offshore wind farming industry. The precision handling and expert maneuverability of a vessel fitted with Volvo Penta IPS ensure that it can be held in a steady position against the wind turbine, more or less undisturbed by current, wind or waves, using the unit’s active steering and high thrust.

The quadruple installations are a step in the right direction for Volvo Penta, opening the market for new opportunities. Although crew transfer vessels within the industry are growing in size, Volvo Penta is able to offer highly efficient quadruple installations, giving added redundancy to four separate engines and drivelines. In this way, Volvo Penta ensures that it can meet the demands of companies wanting to travel farther away from the coastline to more remote locations at sea to harvest wind energy.



MULTIPLE INSTALLATIONS - DIESEL-ELECTRIC PROPULSION

Using high-speed engines as prime movers is the most cost-efficient answer to a broad range of marine power needs. Compared with an installation based on fewer and larger engines, an installation of multiple Volvo Penta engines gives several benefits such as improved fuel efficiency, increased load-sharing capacity and better redundancy.

Environmental performance

Facing increasing environmental demands, a growing number of harbors require visiting ships to use low-sulphur fuel. The Volvo Penta auxiliary engine range is optimized for running on low-sulphur fuel, a fuel that also contributes to longer service intervals and increased engine uptime.

The “green concept” vessel, Tharsis, with diesel electric propulsion by three Volvo Penta D13 came in as number four on Rotterdam environmental index ESI. The ESI is a certificate that has been issued since 1 January 2011 by the World Port Climate Initiative, at the request of ship owners. The index is an indication of the environmental performance of vessels based on their emissions of air pollutants (NOx and SOx) and CO2, source: American Journal of Transportation.

With a strong installation track record, the Volvo Penta genset is a proven concept. Our generating sets are well-suited for diesel electric installations due to their fuel-efficiency, very low exhaust emissions and excellent compatibility with power-management systems.

Maintenance on schedule

A multi-set installation makes it possible to perform even advanced service operations without compromising the regular power supply.

Economical operations

Multi-engine synchronizing and load sharing enable each engine to operate at peak efficiency, which optimizes fuel economy and reduces maintenance costs. The high-speed engine alternative is also advantageous from a capital cost point of view.



VOLVO PENTA IPS

Superior to inboard shafts in every vital aspect – handling, onboard comfort and performance, Volvo Penta IPS has revolutionized the marine industry.

FEATURES AND BENEFITS

Volvo Penta IPS provides what seems to be an impossible combination: dramatically improved performance, longer operating range and, at the same time, radically reduced CO2 emissions – compared with inboard shafts and waterjet propulsion

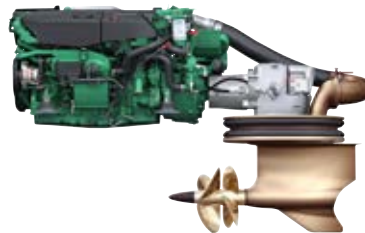

OPTIONS

Volvo Penta IPS is available with a range of functions that can be tailored to the needs of your application. Designed to make life at sea easier, they allow you to concentrate on your operations with precise control, active steering and increased safety.

ENGINES AND PODS

The IPS engine range consists of six models, from D6-IPS400 to D13-IPS1050, matched to three different pod sizes and available for twin, triple and quadruple installations.



FEATURES AND BENEFITS



Forward thinking

Volvo Penta's Inboard Performance System (IPS) with forward-facing, twin counter-rotating propellers is developed as a modern, alternative to traditional inboard shafts. Combined with its individually steerable pods under the hull, it is superior to inboard shafts in every vital aspect – handling, onboard comfort and performance.

Volvo Penta IPS comes as complete packages, from one supplier, for twin, triple or quadruple diesel installations – making forward-facing efficiency available for fast work boats, patrol boats and passenger ferries up to 30 meters and 45 knots.

The benefits of Volvo Penta IPS

- 40% longer cruising range
- 20% higher top speed
- 30% reduced fuel consumption
- 30% less CO₂ emissions
- 50% lower perceived noise level
- Safe and predictable handling
- Joystick for superior maneuverability
- Fully classified installations

Compared with inboard shafts at cruising with planing hulls, approximate figures.



IPS compared with traditional inboard shafts

- High efficiency gives high top speed and reduced fuel consumption at cruising
- Longer cruising range
- Complete and integrated system from one supplier
- Excellent onboard comfort with minimal noise and vibrations
- Propellers works in undisturbed water which reduces the risk for cavitation
- Immediate response and predictable handling
- Low levels of exhaust fumes and smell
- Unique low-speed maneuverability and perfect handling at high speed
- Better grip in the water due to minimal propeller hub for maximal blade area
- Larger active blade area
- Joystick for easy docking, high precision, and driving
- Dynamic Positioning System safe maneuvering when waiting to refuel or preparing for off loading of equipment and personnel at an offshore site.
- The limited engine space needed gives more onboard space and bigger flexibility in the boat layout



Forward-facing efficiency

The twin counter-rotating propellers face forward and work in undisturbed water. The propeller thrust is parallel with the hull. All power drives the boat forward.



Virtually no fumes

All exhaust fumes are emitted through the pods, into the prop wash and carried well behind the boat for improved onboard comfort.

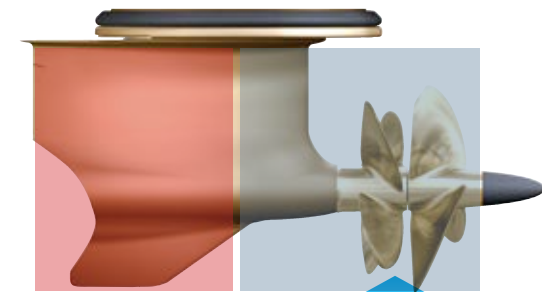

Cavitation-free

The propellers are positioned well under the hull to eliminate the risk of air intrusion and cavitation, even in sharp turns and during full acceleration.



A perfect match – from helm to props

Volvo Penta IPS is a complete and integrated propulsion system – from the helm station to the propellers. This greatly increases quality and reliability. Designed with safety as a key feature, Volvo Penta IPS offers a robust construction and redundancy in the EVC system.

Volvo Penta IPS also has a series of built-in features to reduce the risk of leakage in the event of an impact. Excellent maneuverability with one engine increases safety even more.

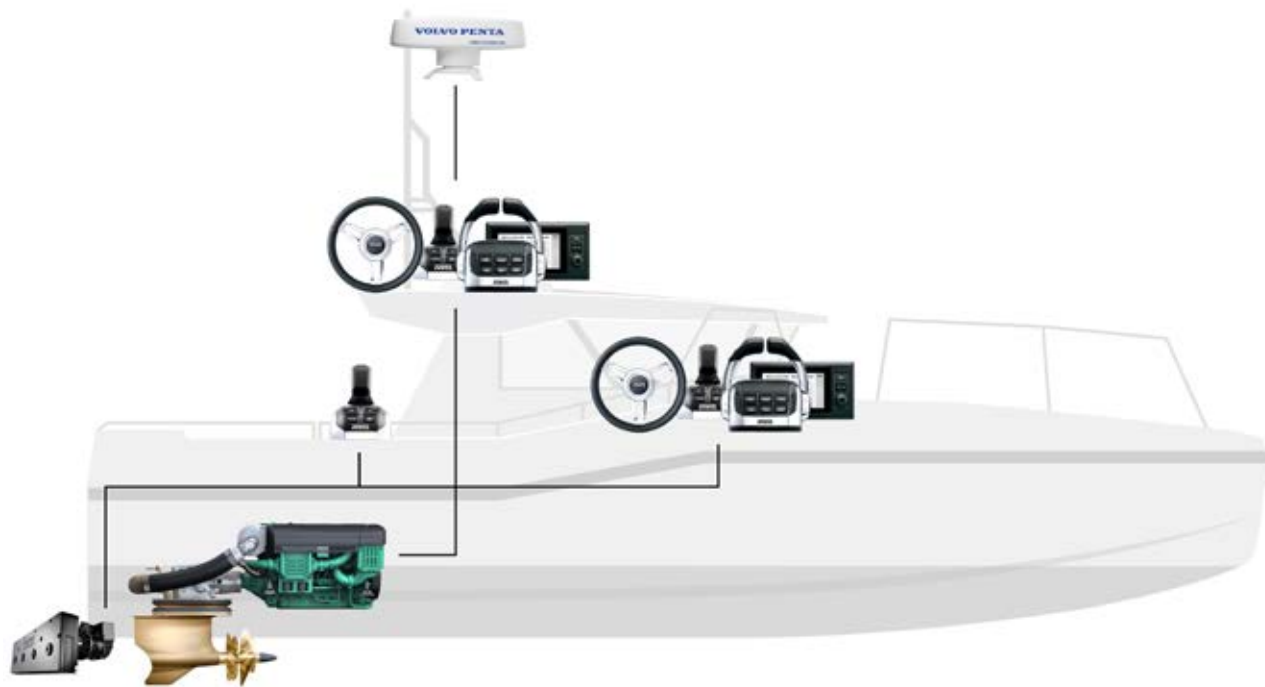

All engineered by Volvo Penta

Volvo Penta IPS is a complete package where the engine, electronic control system, pod and propellers have been developed in parallel to match each other perfectly. We have developed three different pod sizes that are carefully engineered to match the power and torque of each engine. This means that the efficiency and reliability of Volvo Penta IPS is always completely maintained

One contact

With Volvo Penta IPS you have one contact for everything. The components of the entire propulsion system can be obtained directly from your local Volvo Penta dealer. This means easy service and that you are back on the water more quickly if you have a mishap during the season.



ENGINES AND PODS

The IPS engine range consists of six models, from IPS400 to IPS1050, matched to three different pod sizes and available for twin, triple and quadruple installations.

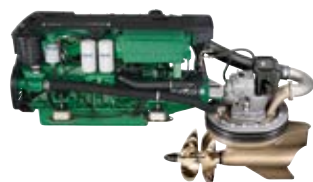

IPS400MC & IPS450

- Volvo Penta D6
- 5.5 liters
- 6 cylinders, In-line
- 221-243 kW / 310-330 hp
- Rating 4



IPS650 & IPS800

- Volvo Penta D11
- 11 liters
- 6 cylinders, In-line
- 375-460 kW / 510-626 hp
- Rating 3, 4

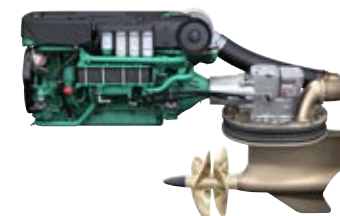

IPS900 & IPS1050

- Volvo Penta D13
- 13 liters
- 6 cylinders, In-line
- 515-588 kW / 700-800 hp
- Rating 3, 4

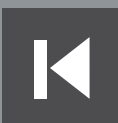

IPS400MC & IPS450

IPS400MC and IPS450 are powered by the 6-cylinder D6, a 5.5-liter, EVC-managed, common-rail diesel with a turbocharger and aftercooler.

Features

- Totally integrated system with everything from steering wheel to propeller cone
- Unique, steerable pods
- Integrated seawater and exhaust system
- Twin rubber suspension and sealing rings plus soft suspended engines
- Patented counter-rotating propellers
- IMO NOx Tier II family certificate
- Compliant with US EPA Tier 3 emission standards
- Type-approved



Application chart

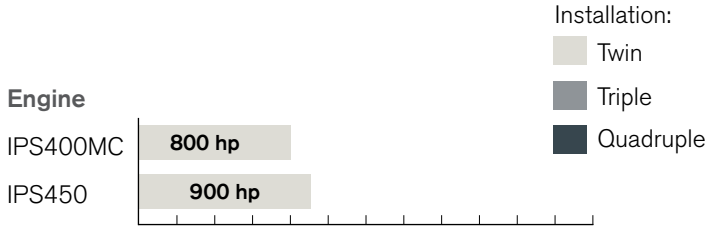

Propellers for IPS400MC & IPS450



Type T
For IPS units with a power output of up to 243 kW.



Type TS
For IPS units with a power output of up to 243 kW specially designed for semi-planing boats.

*The IPS designation corresponds to the approximate crankshaft power (hp) needed from an equivalent inboard shaft installation with a planing hull.



IPS650 & IPS800

The mid-range models are powered by the 6-cylinder D11. This EVC-managed diesel has a twin-entry turbocharger, mechanical compressor and after cooler. With significantly larger pods than the 400-450 models, these drive packages are perfectly matched to the engine's considerably larger torque.

Features

- Totally integrated system with everything from steering wheel to propeller cone
- Unique, steerable pods
- Integrated seawater and exhaust system
- Twin rubber suspension and sealing rings plus soft suspended engines
- Patented counter-rotating propellers
- IMO NOx Tier II family certificate
- Compliant with US EPA Tier 3 emission standards
- EU IWW certificate available for propulsion



Application chart

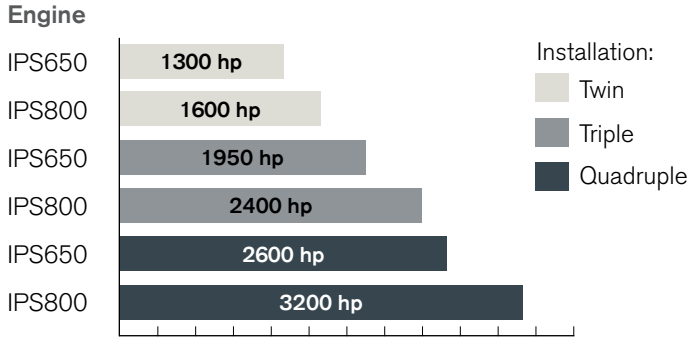

Propellers for IPS650 and IPS800



Type P
For IPS units with power output of 460 kW.



Type PS
For IPS units with a power output of 460 kW.

*The IPS designation corresponds to the crankshaft power (hp) needed from an equivalent shaft installation.



IPS900 & IPS1050

The largest IPS models are powered by the EVC-managed, 6-cylinder D13. Thanks to its twin-entry, dual-stage turbocharger, aftercooler and electronic fuel injection, it provides high torque at a low rpm. The pod and propeller series are also the largest in the range, exclusively developed for the engines characteristics.

Features

- Totally integrated system with everything from steering wheel to propeller cone
- Unique, steerable pods
- Integrated seawater and exhaust system
- Twin rubber suspension and sealing rings plus soft suspended engines
- Patented counter-rotating propellers
- Fully classifiable propulsion system (IPS900)
- IMO NOx Tier II family certificate
- Compliant with US EPA Tier 3 emission standards
- EU IWW certificate available

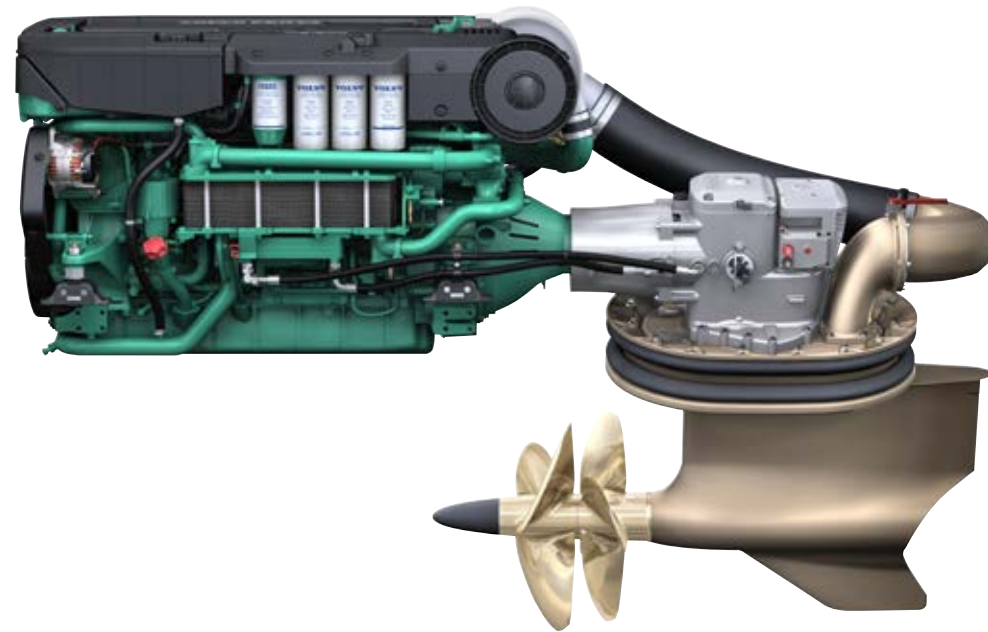

Application chart

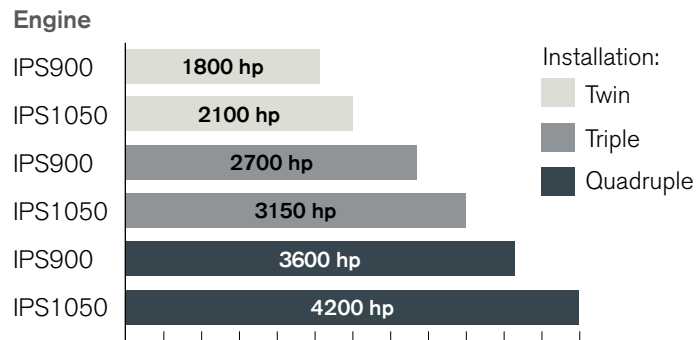

Propellers for IPS900 and IPS1050



Type Q
 For IPS units with power outputs over of 588 kW.



Type QS
 For IPS units with a power output of 588 kW, specially designed for semi-planing boats.

*The IPS designation corresponds to the approximate crankshaft power (hp) needed from an equivalent inboard shaft installation with a planing hull.



OPTIONS

By fully integrating a boat's engines, electronics and unique optional functions to one platform, the type-approved Volvo Penta Electronic Vessel Control (EVC) provides outstanding performance and safety. The EVC provides full monitoring, protection and diagnostics for both engine and transmission

Extend your IPS system with unique capabilities from the broad range of smart accessories and new functions which are easy to install.



Station Handling

Transfer under way with station priority. Up to six helmstations that can be configured as main, local and remote.



Extended Alarm handling

In order to fulfill the monitoring requirements the 7" Color display can be complemented with a steering gear display with continuous status monitoring of the steering machinery status and an alarm handling display including an extended alarm log.



Independent shut down system

Two levels of shut down systems, type approved with shutdown for overspeed and extended type approved with shutdown for overspeed, Coolant temp, Oil pressure, transmission oil pressure.



PTO mode (triple IPS)

The PTO mode is available for triple installations where the center engine can be disengaged and work as an AUX application e.g. driving a fire pump.



Boat speed limiter

The function makes it possible to limit the maximum RPM for the engine and thereby limit the maximum speed of the boat.

Volvo Penta Information Gateway

IGW is a possibility for boatbuilders who want to integrate all drive line information and alarm handling into a ship system. The IGW will also transmit all data from the engine and steering system that is needed to interface a Voyage Data Recorder. Volvo Penta's integration support team will ensure that all connections are established.



Low-speed Mode

With the low-speed mode for Volvo Penta IPS and shaft installations you reduce boat speed at idling by 50% – from 5–6 knots to 2–3 knots. Total system integration gives seamless operation with the standard controls.



Joystick Driving

For simple and ergonomic driving the joystick driving controls the vessel with the finger tip. By twisting the knob you can set an offset to the rudder to keep the course straight even with side wind or current. All of this opens up for creative and ergonomic helm station solutions.



Interceptor System (IS)

Perfect trim and balance. The robust interceptor trim system IS, provides optimal boat attitude in all conditions and increased visibility during acceleration and in sharp turns.



Dynamic Positioning System

Keep your boat still and steady. Press a button and hold your boat's position and heading practically still and steady with the Dynamic Positioning system - for safe maneuvering when waiting to refuel or preparing for offloading of equipment and personnel at an offshore site. Not type approved.





Trip Computer Software

Get advanced trip computer functions in your boat – just like in your car. Information about trip distance, average speed, instant fuel consumption, distance to empty, trip time and much more will help you plan your driving.



Cruise Control

With fingertip control of your engine rpm, you can fine-tune your boat's speed for best possible fuel economy and comfort. Located on the control, the Cruise Control button is easy to reach.



Joystick Docking

Fingertip handling with perfect precision, with Joystick Docking, every docking maneuver is rapid and exact. Just move the joystick in any direction and your boat will follow. You can install up to six docking stations wherever you have the best view.



Single-lever Mode

Lets you operate shift and throttle for twin, triple or quad engines with only one lever for easy and precise control over the boat speed. Very comfortable and safe when driving in rough seas.



Glass Cockpit System

7" color display. The display shows all available information the way you want it: digital or analogue readers, tailored or standard view, etc. for up to three engines. Navigation part not wheelmarked.



Autopilot

The perfect support to the boat driver. The autopilot locks automatically to all steering-wheel course changes (shadow drive). A complete plug-and-play system, fully integrated in the Volvo Penta EVC platform. Not wheel marked.



AQUAMATIC STERNDRIVE

The Aquamatic sterndrive is the world's leading sterndrive – an optimal combination of performance, driving experience and comfort in vessels.

FEATURES AND BENEFITS

The Aquamatic sterndrive offers unique performance and qualities in comparison with traditional outboards and inboard shafts.



OPTIONS

The Aquamatic sterndrive can be extended with unique options for safer boating – developed and manufactured by Volvo Penta – for a perfect match and optimal functionality.

DRIVES

Drives for diesel engines.



DIESEL ENGINES

A perfectly matched package – from controls to engine, drive and propellers – that is available with a wide range of fuel-efficient and diesel engines.



FEATURES AND BENEFITS

Reliable and powerful

The aquamatic is the world's leading sterndrive. In its own unique way, the aquamatic sterndrive offers a total solution for professionals who need an optimal combination of performance, maneuverability and comfort.

It combines the benefits from the inboard system with those from the outboard system. Combining these benefits with the counter-rotating twin propellers, the duoprop, gives an unmatched and fuel-efficient performance for any professional application with responsive handling and safe grip. The diesel engine crankshaft output ranges from 140 to 400 hp (single installations). High performance diesel engines and sterndrives are designed and built expressly for the heavy maritime environment and professional usage. Unique in the world.

The Volvo Penta sterndrive is a perfectly matched package – from controls to engine, drive and propellers – available with a wide range of fuel-efficient diesel engines, designed, built and serviced from one supplier.

The benefits of the Aquamatic sterndrive

- Low fuel consumption
- High Reliability
- Low CO₂ emissions
- Low noise and vibrations
- Excellent low-speed maneuverability
- Beach and shallow-water tilt
- Joystick for superior maneuverability
- Powertrim Assistant



Aquamatic compared with outboards

- Diesel available from 140 hp — much lower fuel consumption
- Duoprop for better handling and performance
- Freshwater cooling as standard or option for longer service life
- Lower center of gravity – better sea-keeping
- Engine safely inside the boat – longer life
- Optional Powertrim assistant, Tow-mode and Joystick
- Uncluttered transom – easy access to the water

Aquamatic compared with traditional inboard shafts

- Reduced sound and vibrations – better onboard comfort
- Improved handling and easier maneuvering
- Compact, integrated installation at the stern gives more onboard space
- Duoprop for better handling and performance
- Higher efficiency – better performance and lower fuel consumption
- Kick-up function on drive for impact protection
- Exhausts emitted through drive, into prop wash away from boat
- Powertrim and optional Powertrim assistant to automatically optimize ride
- Joystick as an option

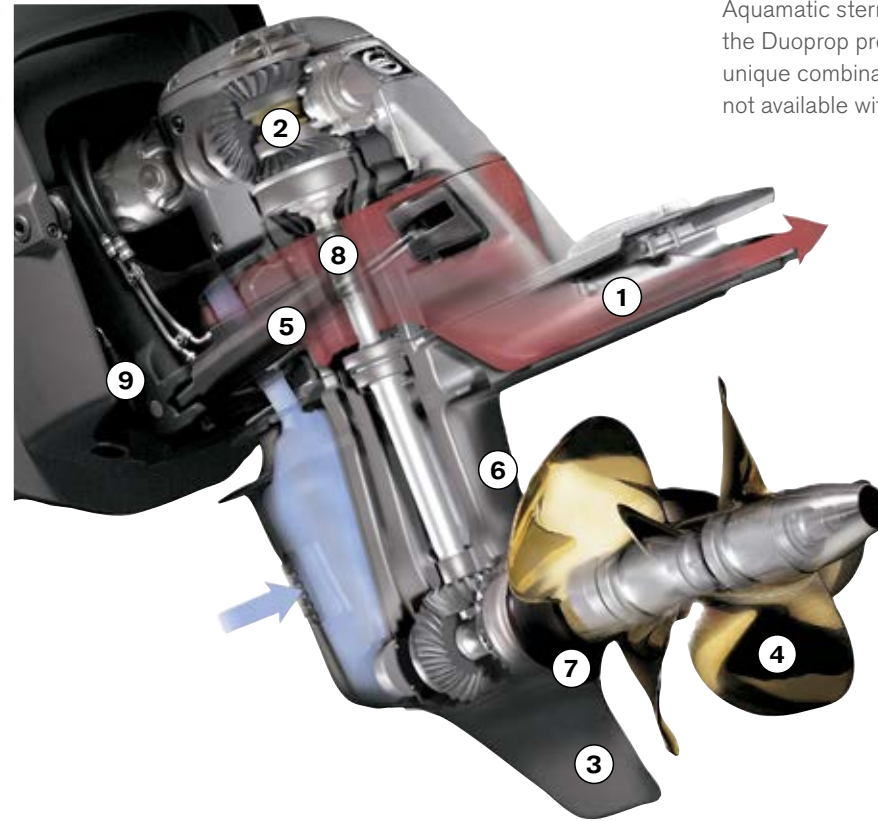

Unique features

The Volvo Penta engines, the Aquamatic sterndrive drives and the Duoprop propellers offer a unique combination of features not available with other brands:

1. Genuine through-the-drive exhaust leads fumes away and reduces noise.
2. Smooth shifting and exceptional durability with patented cone clutch.
3. Excellent corrosion resistance from saltwater-grade aluminum and multi-layer paint process.
4. Patented nickel-bronze-aluminum alloy propellers: extremely strong, corrosion and growth-resistant (DPH).
5. Patented, fully hydraulic and X-act steering with superior steering control (DPH).
6. Hydrodynamically designed lower housing reduces drag and increases performance.
7. Patented “booster ring” that optimizes water flow to the propellers (DPH).
8. The break-away shaft coupling is designed to protect the transmission by shearing if the propellers strike a submerged object at speed.
9. Hydraulic powertrim with integrated kick-up function minimizes damage if a large underwater object is struck.



AQUAMATIC STERNDRIVE DIESEL ENGINES

A perfectly matched package – from controls to engine, drive and propellers – that is available with a wide range of fuel-efficient and high performance diesel engines.



D3-series

- 2.4 liters
- 5 cylinders
- 130-162 kW / 140-220 hp*
- Rating 5



D4-series

- 3.7 liters
- 4 cylinders
- 165-221 kW / 225-300 hp*
- Rating 4, 5



D6-series

- 5.5 liters
- 6 cylinders
- 221-294 kW / 301-400 hp*
- Rating 4, 5

*Parts of this power range is intended for pleasure craft applications, and can be used for high speed planing craft in commercial applications with special limited warranty, see warranty and service book.



D3-series

This all-aluminum, lightweight and high-tech engine delivers performance with light weight and high reliability.

With its robust design, this 5-cylinder, in-line, common-rail diesel delivers up to 162 kW. It is compact and light; at only 363 kg/799 lbs. Complete with a DPS drive, it also meets the world's most stringent emission standards.

Features

- In-line 5-cylinder
- Common-rail fuel injection
- Variable-geometry turbo
- Electronic controls are standard
- Engine-mounted seawater filter
- Robust design with ladder frame bolted to engine block
- Genuine through-the-drive exhaust
- Compliant with US EPA Tier 3 (Leisure) emission standards
- IMO NOx Tier II family certificate
- Approved for life and rescue boats according to MED (SOLAS)

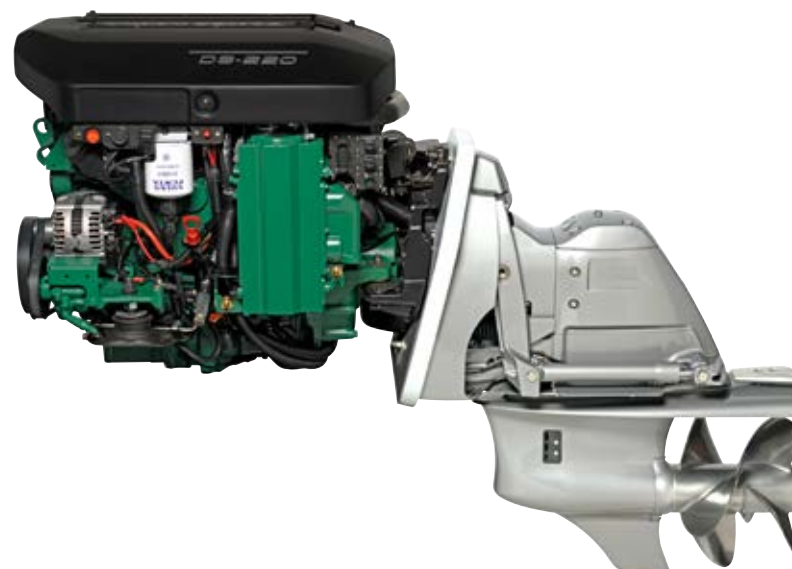

Drive for the D3 diesel engine



DPS Duoprop

Provides amazing driving feel and safety. Hydrodynamic design and high gear train efficiency for higher speed and better performance.

D4-series

This 4-cylinder, 3.7-liter diesel engine deliver outstanding performance, low end torque and low fuel consumption. D4 and D6 are designed and built by Volvo Penta Only for marine use: the only ones worldwide. The environmentally friendly D4 series is not only fuel efficient, but also has reduced noise levels, vibrations and exhaust fumes – all leading to a more efficient working cycle and minor footprint.

Features

- In-line 4-cylinder
- Common-rail fuel injection
- Turbo and aftercooler
- Electronic controls are standard
- Compressor on D4-260/300
- Robust design with ladder frame
- Integrated balance shafts
- Engine-mounted seawater filter
- Patented X-act steering with external steering cylinders
- Patented nickel-bronze-aluminum alloy propellers
- Genuine through-the-drive exhaust
- Compliant with US EPA Tier 3 emission standards
- IMO NOx Tier II family certificate
- Approved for life and rescue boats according to MED (SOLAS)



Drive for the D4 diesel engine



DPH Duoprop

Developed to handle the tremendous torque of the D4 and D6. External hydraulic steering cylinders and patented propellers give optimum driving safety with outstanding reliability.

D6-series

A true masterpiece based on the proven D6 engine range and a further developed duoprop drive. D6 and D4 are designed and built by Volvo Penta Only for marine use: the only ones worldwide. With responsive and safe handling at both low and high speeds, performances are top class and fuel economy is equally impressive.

Features

- In-line 6-cylinder
- Common-rail fuel injection
- Turbo and aftercooler
- Electronic controls are standard
- Compressor on D6-370 and 400
- Robust design with ladder frame
- Engine-mounted seawater filter
- Patented X-act steering with external steering cylinders
- Patented nickel-bronze-aluminum alloy propellers
- Genuine through-the-drive exhaust
- Compliant with US EPA Tier 3 emission standards
- IMO NOx Tier II family certificate
- Approved for life and rescue boats according to MED (SOLAS)



Drive for the D6 diesel engine



DPH Duoprop

Developed to handle the tremendous torque of the D4 and D6. External hydraulic steering cylinders and patented propellers give optimum driving safety with outstanding reliability



DRIVES FOR DIESEL ENGINES

For all the typical qualities of Aquamatic, the drives are vital parts of the perfectly matched packages, from controls to engine, drive and propellers.



DPH Duoprop

- D4-series
- D6-series



DPS Duoprop

- D3-series



DPH Duoprop drive

Developed to handle the tremendous torque of the D4 and D6. External hydraulic steering cylinders and patented propellers give optimum driving safety and performance.

Features

- Robust to handle the torque and power of the D4 and D6
- External hydraulic steering cylinders
- Patented X-act steering with perfect control and driving feel
- Patented, high-strength nickel-bronze-aluminum propellers for minimal growth and corrosion risk
- Electronic shift



Propeller for the DPH drive



Type G - nickel-bronze-aluminum

The 3-blade front and 4-blade rear propeller combination gives tremendous water grip



DPS Duoprop drive

Hydrodynamic design and high gear train efficiency for higher speeds and better performance provide an unbeatable acceleration and grip in the water.

Features

- Hydrodynamically optimized design gives better speed and performance
- Durable internal drive train for longer service life
- Lightweight for better performance
- Reduced maintenance need (e.g. only 2 anodes and maintenance-free gimbal bearing)
- High capacity through-the-drive exhaust for great sound reduction
- Integrated speedometer pick up (US)



Propellers for the DPS drive



Duoprop type IH

The IH-series is the aluminum option for the DPS-B drive.



Duoprop type FH

The FH stainless steel propeller is designed for engines with a DPS drive.



OPTIONS

The aquamatic sterndrive can be extended with unique options for safer and easier professional usage – developed and manufactured by Volvo Penta – for a perfect match and optimal functionality.



Joystick Docking

Fingertip handling with perfect precision makes docking and close-quarter maneuvering simple, faster and safer. Just move the joystick in any direction and your boat will follow, even in tough sea and weather conditions. You can install up to six docking stations wherever you have the best view. For twin installations.



Joystick Driving

A whole new way to maneuver the vessel with precision at all speeds. You steer comfortably by pushing and rotating the joystick. The integrated autopilot supports by automatically engaging after every course change. A smart, new option for intuitive driving. For twin installations.



Autopilot

The perfect support for whom uses the boat for many hours per day. The autopilot locks automatically to all steering-wheel course changes (shadow drive), a complete plug-and-play system, fully integrated in the Volvo Penta EVC platform. For twin installations Not wheel marked.



Cruise Control

With fingertip control of your engine rpm, you can fine-tune your boat's speed for best possible fuel economy and comfort. Located on the control, the Cruise Control button is easy to reach.





Interceptor System (IS)

Automatically optimize the vessel trim angle. The Interceptor System is integrated in the EVC platform which makes it extremely easy to handle; just push the trim assist button on the top-mount control. With the optional automatic mode, trimming is fully automatic.



Boat Trim System (BTS)

Thanks to its patented interceptor technology, the Boat Trim System gives you perfect control over pitch and heel. The result is rapid response, quicker to the plane, lower fuel consumption and a more comfortable ride. Composite material and no hydraulics mean practically no maintenance. Also available with automatic mode.



Powertrim Assistant

An option for aquamatic drives with Volvo Penta electronic Vessel control (EVC). The Powertrim Assistant trims automatically for a safer, more comfortable ride, rapid acceleration and high top speed. It also results in better fuel economy and lower overall exhaust emissions.



Glass Cockpit System

The Volvo Penta Glass Cockpit System is an all-integrated control and monitoring system that gathers all driver information including warnings and alarms – and displays it on a fixed point in the boat; on one or more, high-tech displays.



Trip Computer Software

Get advanced trip computer functions in your vessel. Information about trip distance, average speed, instant fuel consumption, distance to empty, trip time and much more will help you plan your daily job.



Single-lever Mode

Lets you operate shift and throttle for twin, triple or quad engines with only one lever for easy and precise control over the boat speed. Very comfortable and safe when driving in rough seas.



AUXILIARY ENGINE

Volvo Penta engines are renowned for their technical qualities as well as their superior reliability. No matter what your requirements are or what the application is, you will find the perfect auxiliary engine in our broad range of marine diesel engines.

FEATURES AND BENEFITS

Volvo Penta diesel engines will add obvious user benefits such as high serviceability, extreme fuel efficiency and exceptionally low emission levels to your equipment.



VARIABLE SPEED ENGINES

Volvo Penta's variable speed range consists of 5 different engine sizes at rating 1 and 2 covering a wide power range making sure you always can find one that is matched to your requirements.

OPTIONS

Combine the high-performing engines with the Marine Commercial Control system or the Open Can Interface and choose from Volvo Penta's range of additional equipment.



CONSTANT SPEED ENGINES

Volvo Penta's constant speed range consists of 5 different engine sizes at 1500 or 1800 rpm covering a wide power range making sure you always can find one that is matched to your requirements.



FEATURES AND BENEFITS

Volvo Penta the perfect match

When working at sea, the reliability and durability of your auxiliary engines are vitally important for work and life on board.

Thanks to a long-lasting collaboration with leading manufacturers and our own expertise in marine power engineering, we can offer you highly cost-efficient on-board power solutions.

The auxiliary engines are a perfect match for:

- Gensets
- Pumps
- Cranes
- Hydraulic power packs
- Air compressors
- High-pressure water systems
- Fire-fighting equipment
- Nitrogen pumps
- Dry bulk handling
- And much more

Benefits of Auxiliary engines

- Extreme fuel efficiency
- Exceptionally low emission levels
- High serviceability
- Excellent power-to-weight ratio
- Platform commonality
- Easy installation
- Fully classifiable



ENGINES

Volvo Penta's auxiliary constant speed range consists of 5 different engine sizes at 1500 or 1800 rpm covering a wide power range making sure you always can find one that is matched to your requirements.



D5-series

- 4.76 liters
- 4 cylinders In-line
- 73-100 kW
- 1500 / 1800 rpm



D7-series

- 7.15 liters
- 6 cylinders In-line
- 112-148 kW
- 1500 / 1800 rpm



D9-series

- 9.4 liters
- 6 cylinders In-line
- 227-265 kW
- 1500 / 1800 rpm



D13-series

- 12.78 liters
- 6 cylinders In-line
- 289-400 kW
- 1500 / 1800 rpm



D16-series

- 16.12 liters
- 6 cylinders In-line
- 433-500 kW
- 1500 / 1800 rpm



D5-series

The D5A TA is a highly reliable, type-approved, fully classifiable marine diesel engine. Engine speed is well-matched to rated power with excellent torque characteristics. Offering a variety of power take-off options as well as low exhaust emissions, the engine is particularly well-suited for example to genset pump operations.

Features

- Electronically controlled common-rail fuel system
- In-line 4-cylinder
- Easily accessible service points
- Robust design with ladder frame bolted to engine block
- Heavy-duty engine cover
- PTO capability
- MCC control system fully classified
- Fully classifiable
- CCNR Stage 2 certificate available

Available with

Heat exchanger cooling
Keel cooling
Radiator cooling
Central cooling

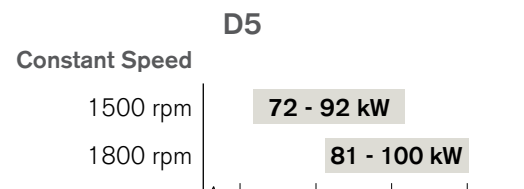
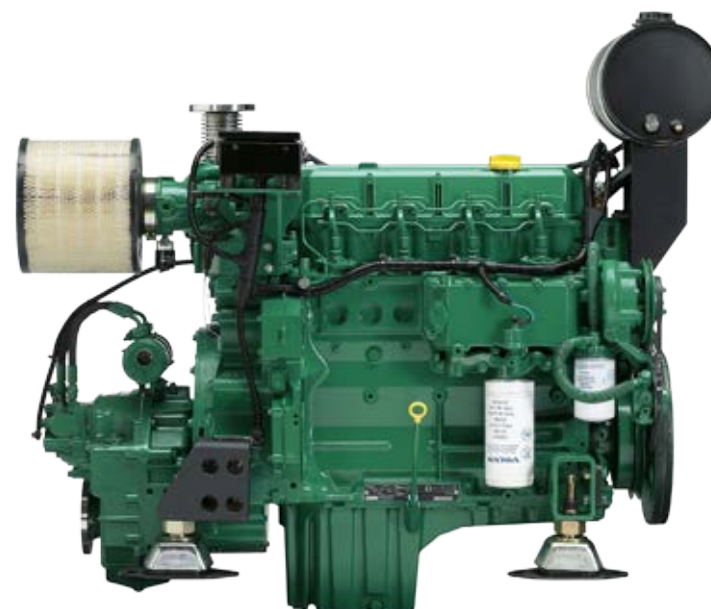

RATING DEFINITIONS

D7-series

The D7A TA is a highly reliable, type-approved, marine diesel engine. Engine speed is well-matched to rated power with excellent torque characteristics. Offering a variety of power take-off options combined with low exhaust emissions that comply with IMO Tier II regulations, the engine is particularly well-suited for example to genset pump operations.

Features

- Electronically controlled common-rail fuel system
- In-line 6-cylinder
- Easily accessible service points
- Robust design with ladder frame bolted to engine block
- Heavy-duty engine cover
- PTO capability
- MCC control system fully classified
- Fully classifiable
- CCNR Stage 2 certificate available
- IMO NOx Tier II family certificate

Available with

- Heat exchanger cooling
- Keel cooling
- Radiator cooling
- Central cooling

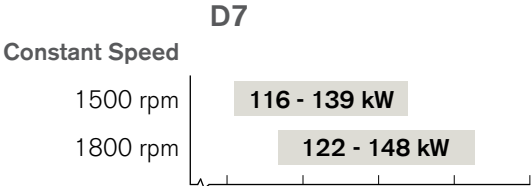

RATING DEFINITIONS



D9-series

The D9 in-line 6-cylinder diesel is developed from the latest design in modern diesel technology. The engine has a robust block with ladder frame, high pressure unit injector system, 4 valves per cylinder, "twin entry" turbo and aftercooler. Together with a large swept volume and the electronic engine management system, this results in a very smooth running engine with world-class diesel performance, combined with low fuel consumption and emissions.

Features

- Twin-entry turbo that enables pulse charging
- Electronically controlled unit injectors
- In-line 6-cylinder
- Easily accessible service points
- Robust design with ladder frame bolted to engine block
- PTO capability
- MCC control system fully classified
- CCNR Stage 2 certificate available
- IMO NOx Tier II family certificate

Available with

Heat exchanger cooling
Keel cooling
Radiator cooling
Central cooling

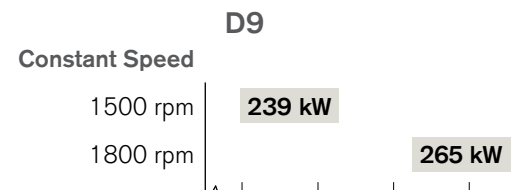

RATING DEFINITIONS

D13-series

Volvo Penta's D13 in-line 6-cylinder diesel is developed from the latest design in modern diesel technology. The engine has a robust block with ladder frame, high pressure unit injector system, 4 valves per cylinder, "twin entry" waste gate turbo and after cooler. All together with the electronic engine management system results in a very smooth running engine with world-class diesel performance, combined with low fuel consumption and emissions.

Features

- Twin-entry turbo that enables pulse charging
- Electronically controlled unit injectors
- In-line 6-cylinder
- Easily accessible service points
- PTO capability
- MCC control system fully classified
- Fully classifiable
- IMO NOx Tier II family certificate
- CCNR Stage 2 certificate available
- IMO NOx Tier II family certificate
- EU IWW certificate available for propulsion (shaft or diesel electric)

Available with

Heat exchanger cooling
Keel cooling
Radiator cooling
Central cooling

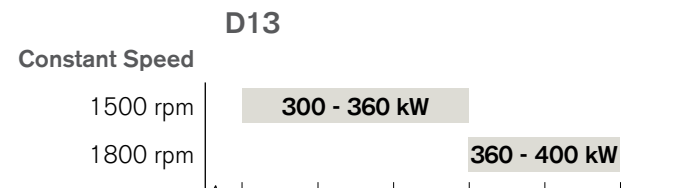

RATING DEFINITIONS

D16-series

The D16 in-line 6-cylinder diesel is specially designed and developed for installations in heavy duty commercial displacement craft, featuring the latest design in modern diesel technology. The engine features a robust block with ladder frame, high pressure unit injector system, 4 valves per cylinder, "twin entry" turbo and charge air cooler. The heat exchanger is designed for reduced charge-air-cooling temperature, which in combination with the injection system, and the Engine Management System (EMS-2) further improve performance and drivability, meeting future stringent emission requirements. This results in a very smooth running engine with world-class performance, combined with low fuel consumption and low emissions.

Features

- Twin-entry turbo that enables pulse charging
- Electronically controlled unit injectors
- In-line 6-cylinder
- Easily accessible service points
- PTO capability
- MCC control system fully classified
- Fully classifiable
- CCNR Stage 2 certificate available
- EU IWW certificate available for propulsion (shaft or diesel electric)

Available with

- Heat exchanger cooling
- Keel cooling
- Radiator cooling
- Central cooling

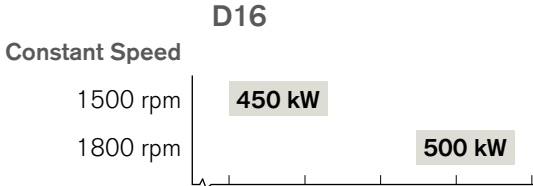

RATING DEFINITIONS



RATING DEFINITIONS

Propulsion

RATING 1

(Heavy Duty Commercial)

For commercial vessels with displacement hulls in heavy operation. Load and speed could be constant, and full power can be used without interruption.

RATING 2

(Medium Duty Commercial)

For commercial vessels with semi planing or displacement hulls in cyclical operation.

Full power could be utilized max 4 h per 12 h operation period.

Between full load operation periods, engine speed should be reduced at least 10 % from the obtained full load engine speed.

RATING 3

(Light Duty Commercial)

For commercial vessels or craft with high demands on speed and acceleration, planing or semi-planing hulls in cyclical operation. Full power could be utilized maximum 2 h per 12 h operation period.

Between full load periods, engine speed should be reduced at least 10% from the obtained full load engine speed.

RATING 4

(Special Light Duty Commercial)

For light planing craft in commercial operation. Recommended speed at cruising = 25 knots. Full power could be utilized max 1 h per 12 h operation period. Between full load operation periods, engine speed should be reduced at least 10% from the obtained full load engine speed.

RATING 5

This power is intended for pleasure craft applications, and can be used for high speed planing craft in commercial applications with special limited warranty, see warranty and service book.

Marine Genset/Auxiliary

PRIME POWER 50 HZ 1500 RPM

(Genset and Auxiliary engines with constant speed ratings) Prime Power: ratings corresponding to ISO Standard Power for continuous operation. This relates to the supplying of electrical power at variable load with 70% load factor for an unlimited number of hours. A 10% overload capability is available with this rating.

PRIME POWER 60 HZ 1800 RPM

(Genset and Auxiliary engines with constant speed ratings) Prime Power: ratings corresponding to ISO Standard Power for continuous operation. This relates to the supplying of electrical power at variable load with 70% load factor for an unlimited number of hours. A 10% overload capability is available with this rating.

MARINE GENSET FOR DIESEL ELECTRIC PROPULSION

Application type: Vessels operating with marine gensets for power to electric propulsion systems. Engine can be run for an unlimited number of running hours at a load factor of < 80%. 10% overload capability is available for maximum of 1 hour per 12 hours operation for this rating. Ratings corresponding to ISO Standard Power for continuous operation.



OPTIONS

Combine the high-performing engines with the Marine Commercial Control system or the Open Can Interface and choose from Volvo Penta's range of additional equipment.

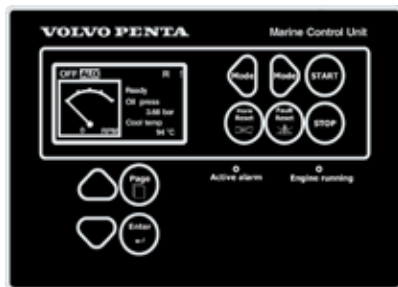

MCC

Marine Commercial Control is a flexible and expandable control and monitoring system, fully classified and fulfills all SOLAS and societies' demands. MCC is an open system that is easily integrated into the ship's control system and it includes a separate safety shut down system. It is a powerful interface for managing multiple installations and efficient load sharing. It enables management of CPP, FPP, thrusters and multiple installations. All readings, actions and events are displayed in easy-to-read text.

Equipment

- Twin fuel pre-filters/water separator with change over valve
- Flexible exhaust compensator
- Cooling water connection bellows
- Electrical and air starting systems available individually or in parallel
- Raw water pressure indication (only in combination with raw water pump)
- Engine heater 2000 W
- Dry exhaust silencer with or without spark arrestor
- 110 A alternator with integrated charging sensor



OPEN CAN

Open Can Interface, gives you the engine delivered without a control system. Different options with or without shut down senders and switches are available.



ENGINES

Volvo Penta's auxiliary variable speed range consists of 5 different engine sizes at rating 1 and 2 covering a wide power range making sure you always can find one that is matched to your requirements.



D5-series

- 4.76 liters
- 4 cylinders In-line
- 89-118 kW
- Rating 1, 2



D7-series

- 7.15 liters
- 6 cylinders In-line
- 130-195 kW
- Rating 1, 2



D9-series

- 9.4 liters
- 6 cylinders In-line
- 221-313 kW
- Rating 1, 2



D13-series

- 12.78 liters
- 6 cylinders In-line
- 294-441 kW
- Rating 1, 2



D16-series

- 16.12 liters
- 6 cylinders In-line
- 368-552 kW
- Rating 1, 2



D5-series

The D5A TA is a highly reliable, type-approved, fully classifiable marine diesel engine. Engine speed is well-matched to rated power with excellent torque characteristics. Offering a variety of power take-off options as well as low exhaust emissions, the engine is particularly well-suited for displacement and semi-planing work boats in medium- and heavy-duty service.

Features

- Electronically controlled common-rail fuel system
- In-line 4-cylinder
- Easily accessible service points
- Robust design with ladder frame bolted to engine block
- Heavy-duty engine cover
- PTO capability
- MCC control system fully classified
- Fully classifiable
- CCNR Stage 2 certificate available

Available with

- Heat exchanger cooling
- Keel cooling
- Radiator cooling
- Central cooling

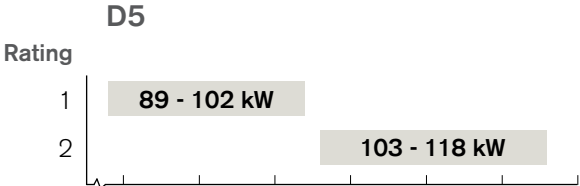

RATING DEFINITIONS



D7-series

The D7A TA is a highly reliable, type-approved, marine diesel engine. Engine speed is well-matched to rated power with excellent torque characteristics. Offering a variety of power take-off options combined with low exhaust emissions that comply with IMO regulations, the engine is particularly well-suited for displacement and semi-planing work boats in medium and heavy-duty service.

Features

- Electronically controlled common-rail fuel system
- In-line 6-cylinder
- Easily accessible service points
- Robust design with ladder frame bolted to engine block
- Heavy-duty engine cover
- PTO capability
- MCC control system fully classified
- Fully classifiable
- CCNR Stage 2 certificate available
- IMO NOx Tier II family certificate

Available with

Heat exchanger cooling
Keel cooling
Radiator cooling
Central cooling

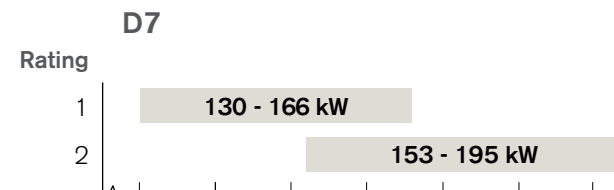

RATING DEFINITIONS

D9-series

The D9 in-line 6-cylinder diesel is developed from the latest design in modern diesel technology. The engine has a robust block with ladder frame, high pressure unit injector system, 4 valves per cylinder, "twin entry" turbo and aftercooler. Together with a large swept volume and the electronic engine management system, this results in a very smooth running engine with world-class diesel performance, combined with low fuel consumption and emissions.

Features

- Twin-entry turbo that enables pulse charging
- Electronically controlled unit injectors
- In-line 6-cylinder
- Easily accessible service points
- Robust design with ladder frame bolted to engine block
- PTO capability
- MCC control system fully classified
- CCNR Stage 2 certificate available
- IMO NOx Tier II family certificate

Available with

- Heat exchanger cooling
- Keel cooling
- Radiator cooling
- Central cooling

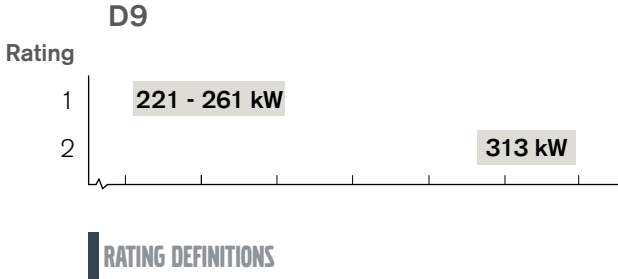

D13-series

Volvo Penta's D13 in-line 6-cylinder diesel is developed from the latest design in modern diesel technology. The engine has a robust block with ladder frame, high pressure unit injector system, 4 valves per cylinder, "twin entry" waste gate turbo and after cooler. All together with the electronic engine management system results in a very smooth running engine with world-class diesel performance, combined with low fuel consumption and emissions.

Features

- Twin-entry turbo that enables pulse charging
- Electronically controlled unit injectors
- In-line 6-cylinder
- Easily accessible service points
- Robust design with compact graphite iron engine block and ladder frame
- PTO capability
- MCC control system fully classified
- Fully classifiable
- EPA Tier 3 Marine Commercial compliance
- CCNR Stage 2 certificate available
- IMO NOx Tier II family certificate

Available with

Heat exchanger cooling
Keel cooling
Radiator cooling
Central cooling

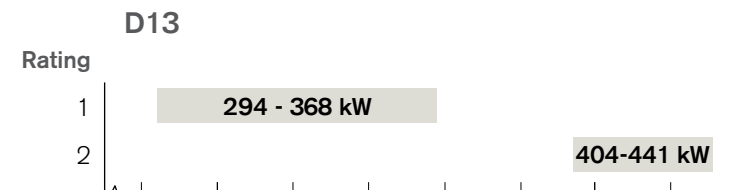

RATING DEFINITIONS

D16-series

The new D16 in-line 6-cylinder diesel is specially designed and developed for installations in heavy duty commercial displacement craft, featuring the latest design in modern diesel technology. The engine features a robust block with ladder frame, high pressure unit injector system, 4 valves per cylinder, "twin entry" turbo and charge air cooler. The heat exchanger is designed for reduced charge-air-cooling temperature, which in combination with the injection system, and the Engine Management System (EMS-2) further improve performance and drivability, meeting future stringent emission requirements. This results in a very smooth running engine with world-class performance, combined with low fuel consumption and low emissions.

Features

- Twin-entry turbo that enables pulse charging
- Electronically controlled unit injectors
- In-line 6-cylinder
- Easily accessible service points
- PTO capability
- MCC control system fully classified
- Fully classifiable
- CCNR Stage 2 certificate available
- IMO NOx Tier II family certificate

Available with

- Heat exchanger cooling
- Keel cooling
- Radiator cooling
- Central cooling

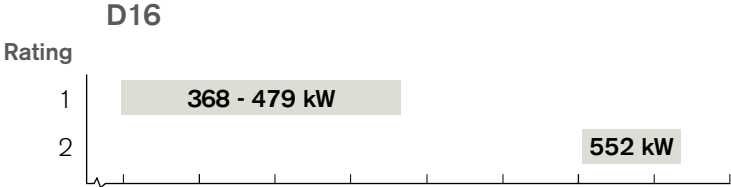

RATING DEFINITIONS



MARINE AND EMERGENCY GENSETS

The Volvo Penta Genset systems are the complete solution for a ship's onboard power requirements. From a company dedicated to the marine industry you not only get reliable marine diesels, well-matched generators and a monitoring system, but also a wide range of other products and services to optimize your investment.

FEATURES AND BENEFITS

Apart from being highly reliable, a Volvo Penta diesel engine will add obvious user benefits such as high serviceability, extreme fuel efficiency and exceptionally low emission levels to your equipment. From a design and manufacturing perspective they also offer high load acceptance capacity and easy installation.

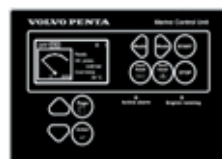

OPTIONS

Combine the high-performing engines with the Marine Commercial Control system or the Open Can Interface and choose from Volvo Penta's range of additional equipment.



MARINE AND EMERGENCY GENSET

Volvo Penta's Genset range consists of 5 different engine sizes at 1500 or 1800 rpm covering a wide power range making sure you always can find one that is matched to your requirements



FEATURES AND BENEFITS

Unique technical features

Thanks to their ability to accept and instantly deliver the sufficient load acceptance, Volvo Penta engines provide higher redundancy – particularly valuable for emergency sets. Performance you can rely on.

Volvo Penta engines are designed to withstand high exhaust back pressure, which makes them perfect for applications that require additional, third-part emission control equipment.

MCC electronic platform is the powerful interface for managing e.g. multiple installations and efficient load sharing.

The platform commonality between Volvo Penta engines – with e.g. shared service and maintenance parts – simplifies parts availability and results in shorter lead times. Thanks to the service competence of the Volvo Penta dealer network, your Volvo Penta gensets' serviceability is further enhanced.

Benefits of Marine and emergency genset

- Extreme fuel efficiency
- Exceptionally low emission levels
- High serviceability
- High load acceptance capabilities
- Low noise level
- High reliability
- Platform commonality
- Easy installation
- Fully classifiable

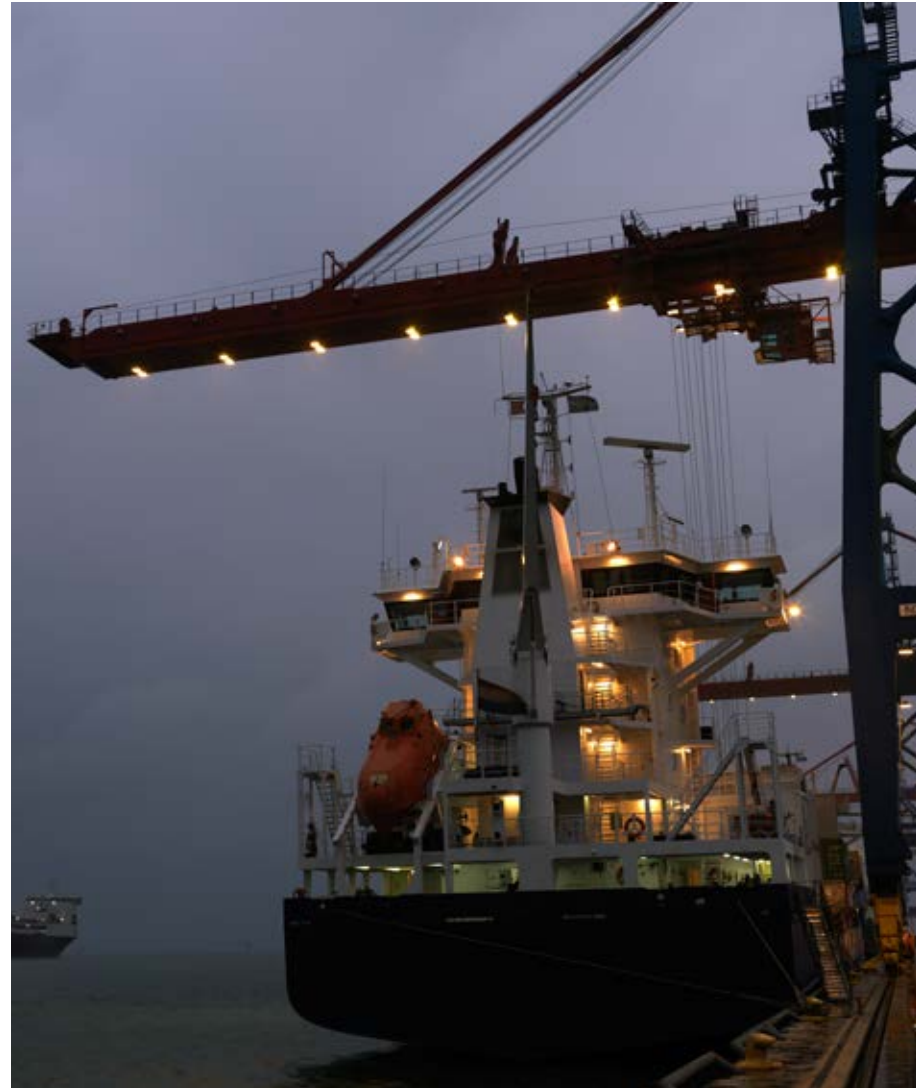

ENGINES

Volvo Penta's Marine and Emergency genset range consists of 5 different engine sizes at 1500 or 1800 rpm covering a wide power range making sure you always can find one that is matched to your requirements.



D5-series

- 4.76 liters
- 4 cylinders, In-line
- 1500/1800 rpm
- MG: 62-93 kWe
- Emergency: 62-69 kWe



D7-series

- 7.15 liters
- 6 cylinders, In-line
- 1500/1800 rpm
- MG: 90-139 kWe
- Emergency: 70-107 kWe



D9-series

- 9.4 liters
- 6 cylinders, In-line
- 1500/1800 rpm
- MG: 160-250 kWe
- Emergency: 136-230 kWe



D13-series

- 12.78 liters
- 6 cylinders, In-line
- 1500/1800 rpm
- MG: 240-380 kWe
- Emergency: 240-362 kWe



D16-series

- 16.12 liters
- 6 cylinders, In-line
- 1500/1800 rpm
- MG: 324-477 kWe
- Emergency: 324-448 kWe



D5-series

The D5A TA is a highly reliable, type-approved, fully classifiable marine diesel engine. Engine speed is well-matched to rated power with excellent torque characteristics. Offering a variety of power take-off options as well as low exhaust emissions, the engine is particularly well-suited for displacement and semi planing work boats in medium- and heavy-duty service.

Features

- Electronically controlled common-rail fuel system
- In-line 4-cylinder
- Easily accessible service points
- Robust design with ladder frame bolted to engine block
- Heavy-duty engine cover
- PTO capability
- MCC control system fully classified
- Fully classifiable
- CCNR Stage 2 certificate available

Available with

- Heat exchanger cooling
- Keel cooling
- Radiator cooling
- Central cooling

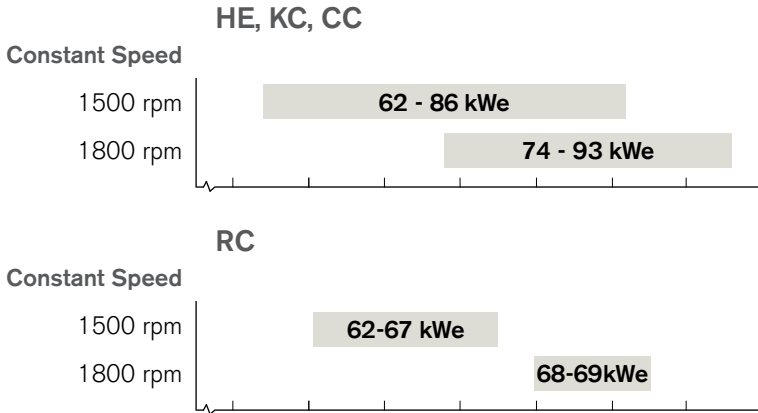
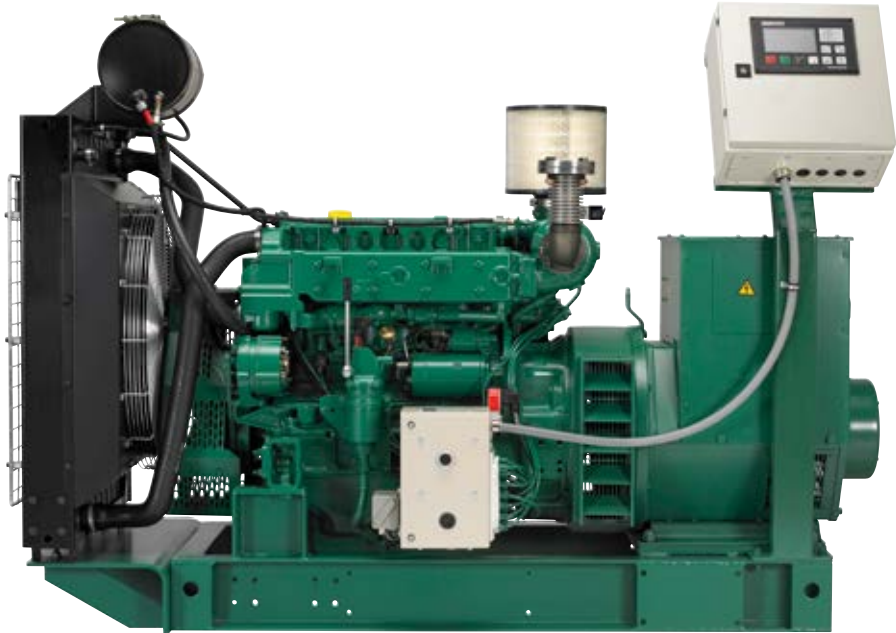

RATING DEFINITIONS



D7-series

The D7A TA is a highly reliable, type-approved, marine diesel engine. Engine speed is well-matched to rated power with excellent torque characteristics. Offering a variety of power take-off options combined with low exhaust emissions that comply with IMO regulations, the engine is particularly well-suited for displacement and semi-planing work boats in medium and heavy-duty service.

Features

- Electronically controlled common-rail fuel system
- In-line 6-cylinder
- Easily accessible service points
- Robust design with ladder frame bolted to engine block
- Heavy-duty engine cover
- PTO capability
- MCC control system fully classified
- Fully classifiable
- CCNR Stage 2 certificate available
- IMO NOx Tier II family certificate

Available with

- Heat exchanger cooling
- Keel cooling
- Radiator cooling
- Central cooling

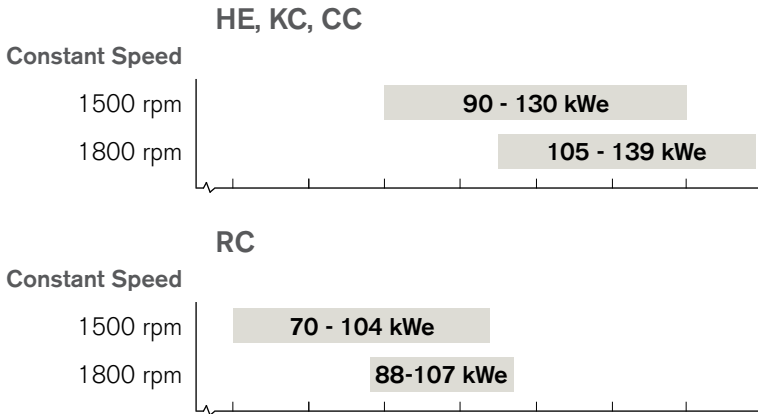
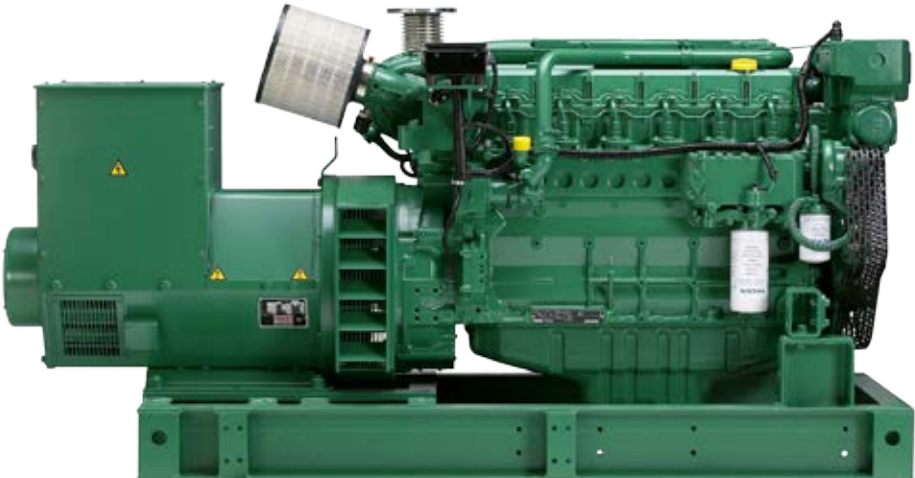

RATING DEFINITIONS



D9-series

The D9 in-line 6-cylinder diesel is developed from the latest design in modern diesel technology. The engine has a robust block with ladder frame, high pressure unit injector system, 4 valves per cylinder, "twin entry" turbo and aftercooler. Together with a large swept volume and the electronic engine management system, this results in a very smooth running engine with world-class diesel performance, combined with low fuel consumption and emissions.

Features

- Twin-entry turbo that enables pulse charging
- Electronically controlled unit injectors
- In-line 6-cylinder
- Easily accessible service points
- Robust design with ladder frame bolted to engine block
- PTO capability
- MCC control system fully classified
- CCNR Stage 2 certificate available
- IMO NOx Tier II family certificate
- EU IWW certificate available for propulsion (shaft or diesel electric)

Available with

- Heat exchanger cooling
- Keel cooling
- Radiator cooling
- Central cooling

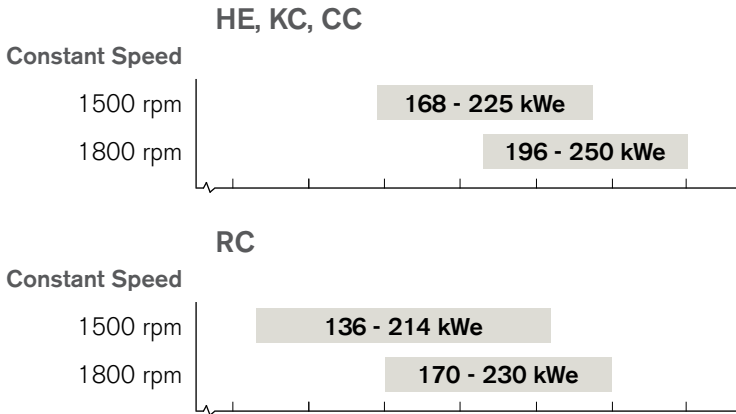
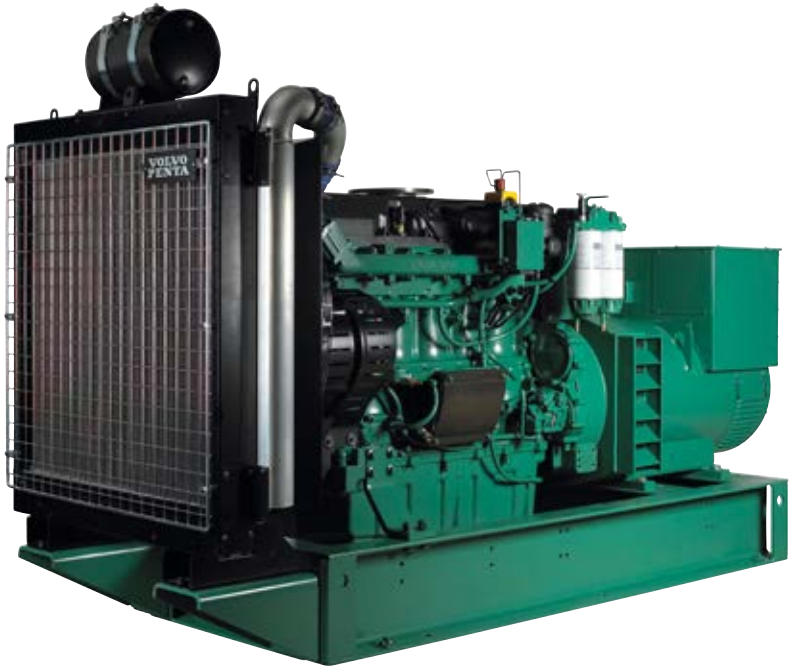

RATING DEFINITIONS



D13-series

Volvo Penta's D13 in-line 6-cylinder diesel is developed from the latest design in modern diesel technology. The engine has a robust block with ladder frame, high pressure unit injector system, 4 valves per cylinder, "twin entry" waste gate turbo and after cooler. All together with the electronic engine management system results in a very smooth running engine with world-class diesel performance, combined with low fuel consumption and emissions.

Features

- Twin-entry turbo that enables pulse charging
- Electronically controlled unit injectors
- In-line 6-cylinder
- Easily accessible service points
- PTO capability
- MCC control system fully classified
- Fully classifiable
- EPA Tier 3 Marine Commercial compliance
- CCNR Stage 2 certificate available
- IMO NOx Tier II family certificate
- EU IWW certificate available for propulsion (shaft or diesel electric)

Available with

- Heat exchanger cooling
- Keel cooling
- Radiator cooling
- Central cooling

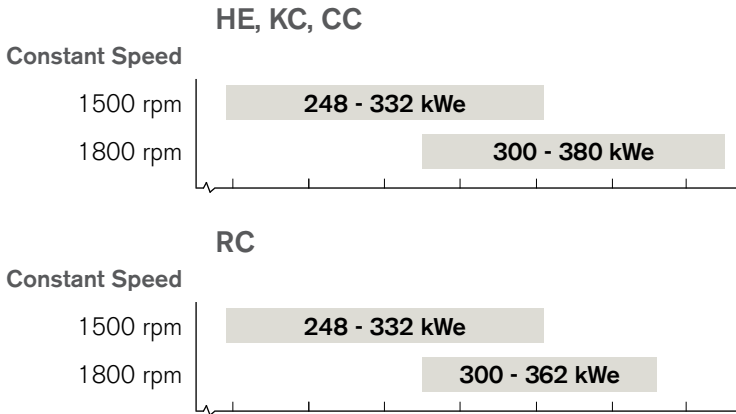

RATING DEFINITIONS



D16-series

The new D16 in-line 6-cylinder diesel is specially designed and developed for installations in heavy duty commercial displacement craft, featuring the latest design in modern diesel technology. The engine features a robust block with ladder frame, high pressure unit injector system, 4 valves per cylinder, "twin entry" turbo and charge air cooler. The heat exchanger is designed for reduced charge-air-cooling temperature, which in combination with the injection system, and the Engine Management System (EMS-2) further improve performance and drivability, meeting future stringent emission requirements. This results in a very smooth running engine with world-class performance, combined with low fuel consumption and low emissions.

Features

- Twin-entry turbo that enables pulse charging
- Electronically controlled unit injectors
- In-line 6-cylinder
- Easily accessible service points
- PTO capability
- MCC control system fully classified
- Fully classifiable
- CCNR Stage 2 certificate available
- IMO NOx Tier II family certificate
- EU IWW certificate available for propulsion (shaft or diesel electric)

Available with

- Heat exchanger cooling
- Keel cooling
- Radiator cooling
- Central cooling



HE, KC, CC

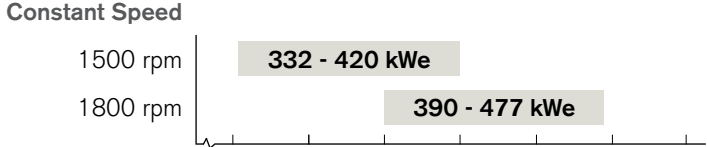

RC

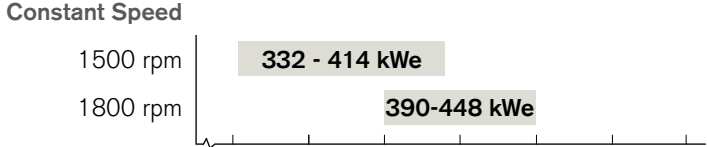

RATING DEFINITIONS



RATING DEFINITIONS

Propulsion

RATING 1

(Heavy Duty Commercial)

For commercial vessels with displacement hulls in heavy operation. Load and speed could be constant, and full power can be used without interruption.

RATING 2

(Medium Duty Commercial)

For commercial vessels with semi planing or displacement hulls in cyclical operation.

Full power could be utilized max 4 h per 12 h operation period.

Between full load operation periods, engine speed should be reduced at least 10 % from the obtained full load engine speed.

RATING 3

(Light Duty Commercial)

For commercial vessels or craft with high demands on speed and acceleration, planing or semi-planing hulls in cyclical operation. Full power could be utilized maximum 2 h per 12 h operation period.

Between full load periods, engine speed should be reduced at least 10% from the obtained full load engine speed.

RATING 4

(Special Light Duty Commercial)

For light planing craft in commercial operation. Recommended speed at cruising = 25 knots. Full power could be utilized max 1 h per 12 h operation period. Between full load operation periods, engine speed should be reduced at least 10% from the obtained full load engine speed.

RATING 5

This power is intended for pleasure craft applications, and can be used for high speed planing craft in commercial applications with special limited warranty, see warranty and service book.

Marine Genset/Auxiliary

PRIME POWER 50 HZ 1500 RPM

(Genset and Auxiliary engines with constant speed ratings) Prime Power: ratings corresponding to ISO Standard Power for continuous operation. This relates to the supplying of electrical power at variable load with 70% load factor for an unlimited number of hours. A 10% overload capability is available with this rating.

PRIME POWER 60 HZ 1800 RPM

(Genset and Auxiliary engines with constant speed ratings) Prime Power: ratings corresponding to ISO Standard Power for continuous operation. This relates to the supplying of electrical power at variable load with 70% load factor for an unlimited number of hours. A 10% overload capability is available with this rating.

MARINE GENSET FOR DIESEL ELECTRIC PROPULSION

Application type: Vessels operating with marine gensets for power to electric propulsion systems. Engine can be run for an unlimited number of running hours at a load factor of < 80%. 10% overload capability is available for maximum of 1 hour per 12 hours operation for this rating. Ratings corresponding to ISO Standard Power for continuous operation.



OPTIONS

Combine the high-performing engines with the Marine Commercial Control system or the Open Can Interface and choose from Volvo Penta's range of additional equipment.

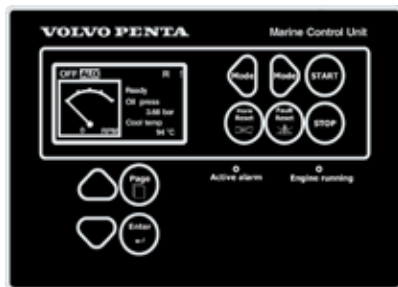

MCC

Marine Commercial Control is a flexible and expandable control and monitoring system, fully classified and fulfills all SOLAS and societies' demands. MCC is an open system that is easily integrated into the ship's control system and it includes a separate safety shut down system. It is a powerful interface for managing multiple installations and efficient load sharing. It enables management of CPP, FPP, thrusters and multiple installations. All readings, actions and events are displayed in easy-to-read text.

Equipment

- Twin fuel pre-filters/water separator with change over valve
- Flexible exhaust compensator
- Cooling water connection bellows
- Electrical and air starting systems available individually or in parallel
- Raw water pressure indication (only in combination with raw water pump)
- Engine heater 2000 W
- Dry exhaust silencer with or without spark arrestor
- 110 A alternator with integrated charging sensor



OPEN CAN

Open Can Interface, gives you the engine delivered without a control system. Different options with or without shut down senders and switches are available.



DIESEL INBOARD

Their unique marine torque and combination of high power, low weight, low fuel consumption and emissions make the Volvo Penta diesel engines the superior choice for all inboard shaft installations.



HEAVY-DUTY

State-of-the-art, reliable and extremely fuel efficient - the characteristics of Volvo Penta marine engines make them a perfect choice for a wide range of heavy duty propulsion applications.



HIGH PERFORMANCE

All the Marine Volvo Penta diesel engines in the range provide the necessary performance for applications requiring fast acceleration and high top speed.



HEAVY-DUTY

State-of-the-art, reliable and extremely fuel efficient - the characteristics of Volvo Penta marine engines make them a perfect choice for a wide range of heavy duty propulsion applications.

FEATURES AND BENEFITS

Based on Volvo Penta's more than century-long marine engine experience, our engines have been developed, manufactured and thoroughly tested to meet operators' demanding needs of reliable, high performing, fuel efficient engines. The unique marine torque of the Volvo Penta diesel engines stands out among the competition.



OPTIONS

Combine the high-performing engines with a state of the art control system and choose from Volvo Penta's range of smart features and equipment.



HEAVY-DUTY ENGINES

Volvo Penta's heavy duty range consists of 5 different engine sizes with various power levels and ratings making sure you always can find one that is perfectly matched to your requirements.



FEATURES AND BENEFITS

Solutions for big challenges

The Volvo Penta heavy-duty range has been developed for extreme reliability. These marine diesels are designed to keep running, year in and year out. The basic design features robust engine blocks manufactured from high-strength castings, large bearing surfaces, powerful crankshafts with all components engineered to withstand the toughest conditions.

Low fuel consumption is high priority, as is low maintenance cost, exhaust and noise emissions and simple service – properties that are vital for the crew as well as for the environment.

The benefits of Volvo Penta heavy-duty engines

- High performing
- Fuel efficient
- Highly reliable
- One company simplicity
- Unique marine torque offers increased load-carrying capability, rapid acceleration, ability to maintain a high cruising speed irrespective of load or sea state.



ENGINES

Volvo Penta's heavy duty range consists of 5 different engine sizes with various power levels and ratings making sure you always can find one that is perfectly matched to your requirements.



D5-series

- 4.76 liters
- 4 cylinders, In-line
- 89-118 kW / 121-160 hp
- Rating 1, 2



D7-series

- 7.15 liters
- 6 cylinders, In-line
- 130-195 kW / 177-265 hp
- Rating 1, 2



D9-series

- 9.4 liters
- 6 cylinders, In-line
- 221-313 kW / 300-425 hp
- Rating 1, 2



D13-series

- 12.78 liters
- 6 cylinders, In-line
- 214-441 kW / 291-600 hp
- Rating 1, 2



D16-series

- 16.12 liters
- 6 cylinders, In-line
- 368-552 kW / 501-751 hp
- Rating 1, 2



D5-series

The D5A TA is a highly reliable, type-approved, fully classifiable marine diesel engine. Engine speed is well-matched to rated power with excellent torque characteristics. Offering a variety of power take-off options as well as low exhaust emissions, the engine is particularly well-suited for displacement and semi-planing work boats in medium- and heavy-duty service.

Features

- In-line 4-cylinder
- Easily accessible service points
- Heavy-duty engine cover
- PTO capability
- Classifiable engine
- EU IMW certificate available
- CCNR Stage 2 certificate available

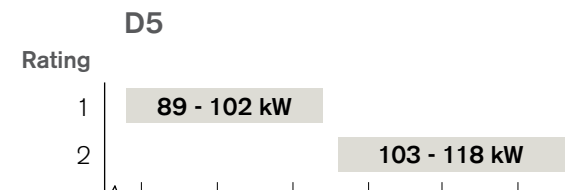

RATING DEFINITIONS

D7-series

The D7A TA is a highly reliable, type-approved, marine diesel engine. Engine speed is well-matched to rated power with excellent torque characteristics. Offering a variety of power take-off options combined with low exhaust emissions that comply with IMO regulations, the engine is particularly well-suited for displacement and semi-planing work boats in medium and heavy-duty service.

Features

- In-line 6-cylinder
- Easily accessible service points
- Heavy-duty engine cover
- PTO capability
- Classifiable engine
- IMO NOx Tier II family certificate
- EU IWW certificate available
- CCNR Stage 2 certificate available

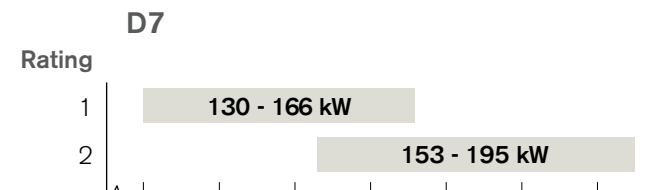

RATING DEFINITIONS

D9-series

The D9 in-line 6-cylinder diesel is developed from the latest design in modern diesel technology. The engine has a robust block with ladder frame, high pressure unit injector system, 4 valves per cylinder, "twin entry" turbo and aftercooler. Together with a large swept volume and the electronic engine management system, this results in a very smooth running engine with world-class diesel performance, combined with low fuel consumption and emissions.

Features

- Twin-entry turbo that enables pulse charging
- Electronically controlled unit injectors
- In-line 6-cylinder
- Easily accessible service points
- Robust design with ladder frame bolted to engine block
- PTO capability
- IMO NOx Tier II family certificate
- EU IWW certificate available

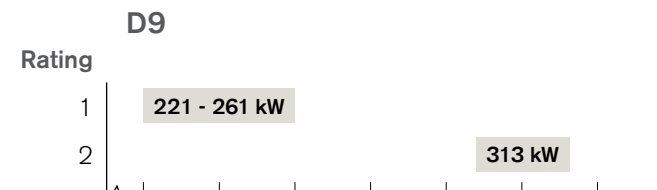

RATING DEFINITIONS

D13-series

Volvo Penta's D13 in-line 6-cylinder diesel is developed from the latest design in modern diesel technology. The engine has a robust block with ladder frame, high pressure unit injector system, 4 valves per cylinder, "twin entry" waste gate turbo and after cooler. All together with the electronic engine management system results in a very smooth running engine with world-class diesel performance, combined with low fuel consumption and emissions.

Features

- Twin-entry turbo that enables pulse charging
- Dual-stage turbo on the D13-900
- Electronically controlled unit injectors
- In-line 6-cylinder
- Easily accessible service points
- Robust design with compact graphite iron engine block and ladder frame
- Quick-shift available
- PTO capability
- Fully classifiable
- IMO NOx Tier II family certificate
- EPA Tier 3 Marine Commercial compliance
- EU IWW certificate available
- CCNR Stage 2 certificate available

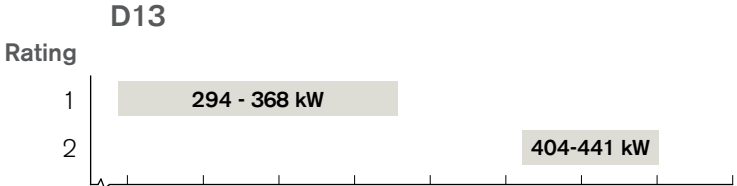

RATING DEFINITIONS



D16-series

The new D16 in-line 6-cylinder diesel is specially designed and developed for installations in heavy duty commercial displacement craft, featuring the latest design in modern diesel technology. The engine features a robust block with ladder frame, high pressure unit injector system, 4 valves per cylinder, "twin entry" turbo and charge air cooler. The heat exchanger is designed for reduced charge-air-cooling temperature, which in combination with the injection system, and the Engine Management System (EMS-2) further improve performance and drivability, meeting future stringent emission requirements. This results in a very smooth running engine with world-class performance, combined with low fuel consumption and low emissions.

Features

- Twin-entry turbo that enables pulse charging
- Electronically controlled unit injectors
- In-line 6-cylinder
- Easily accessible service points
- Robust design with compact graphite iron engine block and ladder frame
- Quick-shift available
- PTO capability
- Fully classifiable
- IMO NOx Tier II family certificate
- EPA Tier 3 Marine Commercial compliance (over 420 kW)
- EU IWW certificate available
- CCNR Stage 2 certificate available

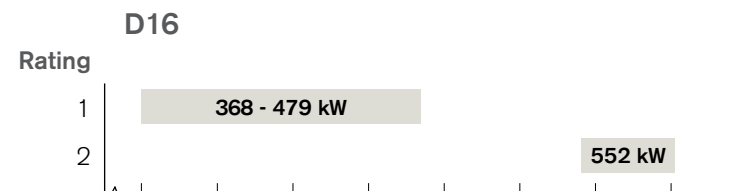

RATING DEFINITIONS

RATING DEFINITIONS

Propulsion

RATING 1

(Heavy Duty Commercial)

For commercial vessels with displacement hulls in heavy operation. Load and speed could be constant, and full power can be used without interruption.

RATING 2

(Medium Duty Commercial)

For commercial vessels with semi planing or displacement hulls in cyclical operation.

Full power could be utilized max 4 h per 12 h operation period.

Between full load operation periods, engine speed should be reduced at least 10 % from the obtained full load engine speed.

RATING 3

(Light Duty Commercial)

For commercial vessels or craft with high demands on speed and acceleration, planing or semi-planing hulls in cyclical operation. Full power could be utilized maximum 2 h per 12 h operation period.

Between full load periods, engine speed should be reduced at least 10% from the obtained full load engine speed.

RATING 4

(Special Light Duty Commercial)

For light planing craft in commercial operation. Recommended speed at cruising = 25 knots. Full power could be utilized max 1 h per 12 h operation period. Between full load operation periods, engine speed should be reduced at least 10% from the obtained full load engine speed.

RATING 5

This power is intended for pleasure craft applications, and can be used for high speed planing craft in commercial applications with special limited warranty, see warranty and service book.

Marine Genset/Auxiliary

PRIME POWER 50 HZ 1500 RPM

(Genset and Auxiliary engines with constant speed ratings) Prime Power: ratings corresponding to ISO Standard Power for continuous operation. This relates to the supplying of electrical power at variable load with 70% load factor for an unlimited number of hours. A 10% overload capability is available with this rating.

PRIME POWER 60 HZ 1800 RPM

(Genset and Auxiliary engines with constant speed ratings) Prime Power: ratings corresponding to ISO Standard Power for continuous operation. This relates to the supplying of electrical power at variable load with 70% load factor for an unlimited number of hours. A 10% overload capability is available with this rating.

MARINE GENSET FOR DIESEL ELECTRIC PROPULSION

Application type: Vessels operating with marine gensets for power to electric propulsion systems. Engine can be run for an unlimited number of running hours at a load factor of < 80%. 10% overload capability is available for maximum of 1 hour per 12 hours operation for this rating. Ratings corresponding to ISO Standard Power for continuous operation.



OPTIONS

Combine the heavy-duty engines with a state of the art control system and choose from Volvo Penta's range of smart features and equipment.

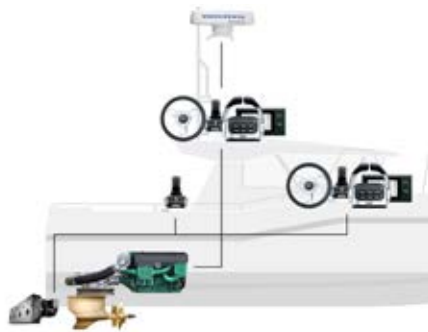

EVC

Electronic Vessel Control is Volvo Penta's own electronic platform with integrated controls and features. By fully integrating a boat's engines, electronics and unique optional functions to one platform, the type-approved EVC provides outstanding performance and safety. You can easily master and monitor all functions through the controls and displays. All updates are simple to perform and there is a broad range of functions available and easy to install.

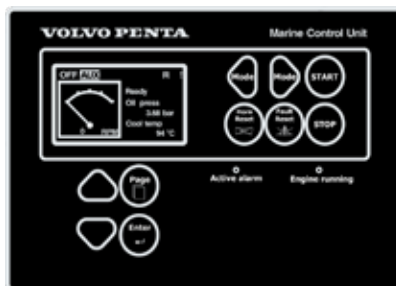

MCC

Marine Commercial Control is an open, expandable, easily integrated system for monitoring and control of the propulsion system fully classified and fulfills all SOLAS approved. It is a powerful interface for managing multiple installations and efficient load sharing. It enables management of CPP, FPP, thrusters and multiple installations. All readings, actions and events are displayed in easy-to-read text.

Equipment

Available equipment examples includes:

- Twin fuel pre-filters/water separator with change over valve
- Flexible exhaust compensator
- Cooling water connection bellows
- Electrical and air starting systems available individually or in parallel
- Raw water pressure indication (only in combination with raw water pump)
- Engine heater 2000 W
- Dry exhaust silencer with or without spark arrestor
- 110 A alternator with integrated charging sensor

HIGH PERFORMANCE

All the Marine Volvo Penta diesel engines in the range provide the necessary performance for applications requiring fast acceleration and high top speed.

FEATURES AND BENEFITS

Low end torque, strengthen your daily job while manoeuvring and accelerating; high load acceptance makes sure that the unbeaten performance remains the same at any load. Low fuel consumption makes your business more profitable and decrease CO2 footprint.



OPTIONS

Combine the high-performing engines with a state of the art control system and choose from Volvo Penta's range of smart features and equipment.

HIGH PERFORMANCE ENGINES

Volvo Penta's high performance range consists of 6 different engine sizes with various power levels and ratings making sure you always can find one that is perfectly matched to your requirements.



FEATURES AND BENEFITS

When time is tight

A service vessel on its way to repair a malfunctioning wind power station, a marine ambulance racing to assist at the scene of an accident, or a coast guard vessel intercepting a suspected smuggler in almost every marine profession, time is the most critical factor. It's often the difference between a successful operation and a failure.

Professional marine operators must be able to trust their equipment and, in particular, their boats. Here, the key to functionality, to uptime and to performance is the boats' engines and drivelines.

The world of marine professionals is the world of Volvo Penta. For more than 100 years, we have been developing, designing, manufacturing and servicing marine drive systems that meet all the demands of the marine environment.

We are proud that operators in a variety of areas and businesses, all over the world, put their trust in our ability to provide outstanding power for marine professionals.

A variety of applications

Volvo Penta type-approved engines together with the EVC or MCC system can be used for any high-performance propulsion system arrangement or requirement.

FPP - The excellent load-carrying capability of the Volvo Penta engines makes them a perfect match for fixed-pitch propeller applications. A range of transmissions are available for different speeds and duty profiles.

CPP - With our high-performance engines, controllable pitch can easily be optimized for different operating conditions, such as transit mode and cruise. Volvo Penta solutions are easily integrated with different transmissions and control systems.

Waterjet - Volvo Penta engines are a perfect match for any type of waterjet, in terms of power/rpm range as well as engine response time.

Surface drives - Thanks to their unique marine torque, Volvo Penta engines are an ideal power source for demanding surface drive applications.

The benefits of Volvo Penta HP engines

- Fuel efficient
- High performing
- Highly reliable
- One company simplicity
- Unique marine torque offers increased load-carrying capability, rapid acceleration, ability to maintain a high cruising speed irrespective of load or sea state.



ENGINES

Volvo Penta's high performance range consists of 6 different engine sizes with various power levels and ratings making sure you always can find one that is perfectly matched to your requirements.



D3-series

- 2.4 liters
- 4 cylinders, In-line
- 81-162 kW / 110-220 hp*
- Rating 5



D4-series

- 3.67 liters
- 4 cylinders, In-line
- 132-221 kW / 180-300 hp*
- Rating 4, 5



D6-series

- 5.5 liters
- 6 cylinders, In-line
- 221-320 kW / 301-435 hp*
- Rating 4, 5



D9-series

- 9.4 liters
- 6 cylinders, In-line
- 313-422 kW / 425-575 hp*
- Rating 3, 4, 5



D11-series

- 10.8 liters
- 6 cylinders, In-line
- 375-496 kW / 510-670 hp*
- Rating 3, 4, 5



D13-series

- 12.78 liters
- 6 cylinders, In-line
- 515-662 kW / 700-900 hp*
- Rating 3, 4, 5

*Parts of this power range is intended for pleasure craft applications, and can be used for high speed planing craft in commercial applications with special limited warranty, see warranty and service book.



D3-series

A lightweight, compact, high-tech, all-aluminum diesel that is absolutely perfect where weight and/or space is an issue.

The D3 features all the latest diesel technology to deliver outstanding performance and excellent onboard comfort with low fuel consumption. 5 cylinders.

Features

- Electronically controlled common-rail fuel system
- Electronic controls are standard
- In-line 5-cylinder
- Variable geometry turbo
- Robust design with ladder frame bolted to engine block
- Easily accessible service points
- IMO NOx Tier II family certificate
- Compliant with US EPA Tier 3 (Leisure) emission standards
- Approved for life and rescue boats according to MED (SOLAS)
- EVC instrumentation with full EVC functionality

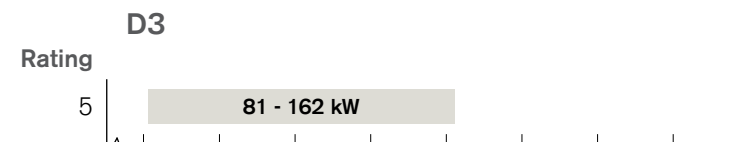

RATING DEFINITIONS

D4-series

The 4-cylinder D4 features all the benefits of the D6 – in a more compact size.

Immediate response and high performance is matched by lower amounts of noise and vibrations further reduced by the balance shafts and the optimized engine suspension. Low fuel consumption gives good overall economy. 4 cylinders.

Features

- Electronically controlled common-rail fuel system
- In-line 4-cylinder
- Compact dimensions
- Electronic controls are standard
- Easily accessible service points
- Robust design with ladder frame bolted to engine block
- Integrated balance shafts
- Heavy-duty engine cover
- PTO capability
- IMO NOx Tier II family certificate
- Compliant with US EPA Tier 3 emission standards
- Approved for life and rescue boats according to MED (SOLAS)
- EVC instrumentation with full EVC functionality

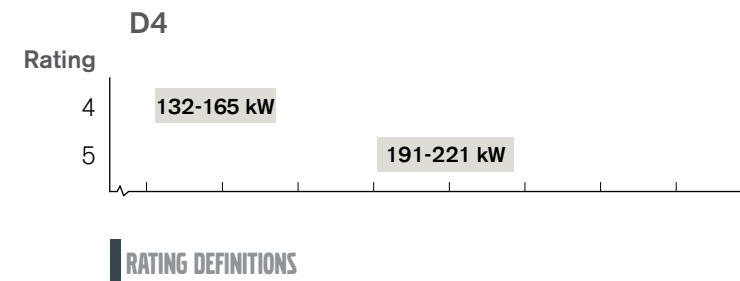

D6-series

This state-of-the-art engine delivers silk-smooth running for onboard comfort and powerful response to driver commands. All thanks to the latest in diesel technology.

Immediate response and high performance is matched by lower amounts of noise and vibrations. Lower fuel consumption gives good overall economy. 6 cylinders.

Features

- Electronically controlled common-rail fuel system
- In-line 6-cylinder
- Electronic controls are standard
- Easily accessible service points
- Robust design with ladder frame bolted to engine block
- Heavy-duty engine cover
- PTO capability
- IMO NOx Tier II family certificate
- Compliant with US EPA Tier 3 emission standards
- Approved for life and rescue boats according to MED (SOLAS)
- EVC instrumentation with full EVC functionality

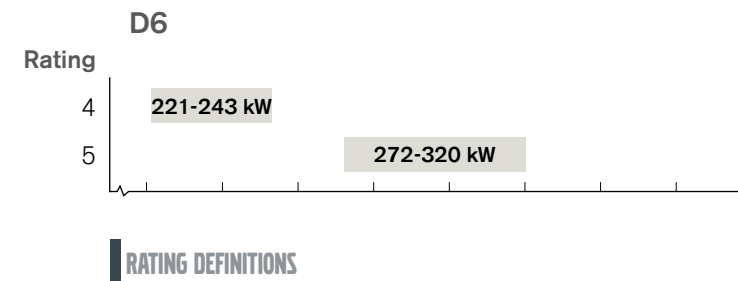

D9-series

The D9 in-line 6-cylinder diesel is developed from the latest design in modern diesel technology. The engine has a robust block with ladder frame, high pressure unit injector system, 4 valves per cylinder, "twin entry" turbo and aftercooler. Together with a large swept volume and the electronic engine management system, this results in a very smooth running engine with world-class diesel performance, combined with low fuel consumption and emissions.

Features

- Twin-entry turbo that enables pulse charging
- Electronically controlled unit injectors
- In-line 6-cylinder
- Electronic controls are standard
- Easily accessible service points
- Robust design with ladder frame bolted to engine block
- PTO capability
- EVC instrumentation with full EVC functionality
- IMO NOx Tier II family certificate
- EU IWW certificate available for propulsion (Rating 3)

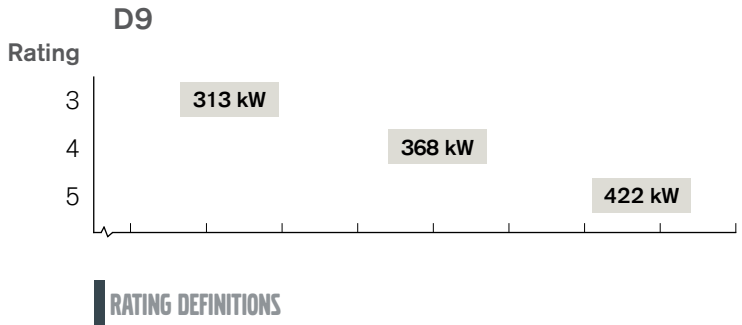
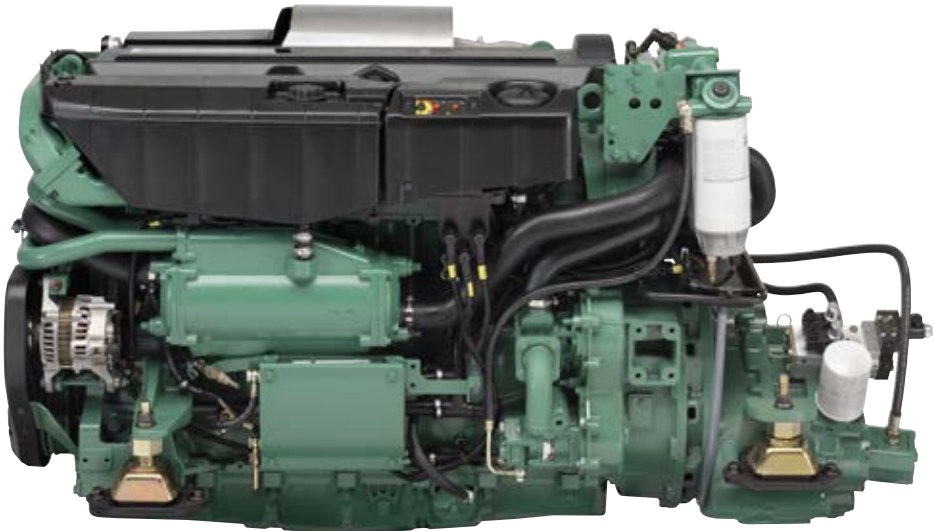

D11-series

This extremely powerful and compact 6-cylinder D11 engine features a unique twin-entry turbo that facilitates magnificent torque for powerful acceleration. This strong and highly efficient engine offers excellent reliability and long action range.

Features

- Twin-entry turbo that enables pulse charging
- Electronically controlled unit injectors
- In-line 6-cylinder
- Electronic controls are standard
- Easily accessible service points
- Robust design with compact graphite iron engine block and ladder frame
- PTO capability
- EVC instrumentation with full EVC functionality
- IMO NOx Tier II family certificate
- Compliant with US EPA Tier 3 emission standards
- EU IWW certificate available for propulsion



RATING DEFINITIONS

D13-series

At the top of the high performance range, this is an engine with outstanding overall performance, yet it is quiet and smooth-running. The fuel economy is world-class and it is more environmentally friendly with low emissions of CO₂.

The secret behind this is the D13 with center-mounted, twin-entry turbo and, on the 900, also a dual-stage turbo. 6 cylinders.

Features

- Dual stage turbo for D13-800 rating 4 and D13-900 rating 5
- Electronically controlled unit injectors
- In-line 6-cylinder
- Electronic controls are standard
- Easily accessible service points
- Robust design with compact graphite iron engine block and ladder frame
- Quick-shift available
- PTO capability
- EVC instrumentation with full EVC functionality
- IMO NO_x family certificate
- Compliant with US EPA Tier 3 emission standards
- EU IWW certificate available for propulsion

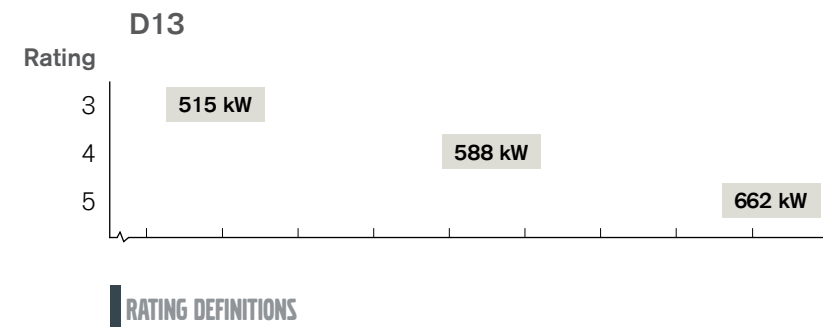

RATING DEFINITIONS

Propulsion

RATING 1

(Heavy Duty Commercial)

For commercial vessels with displacement hulls in heavy operation. Load and speed could be constant, and full power can be used without interruption.

RATING 2

(Medium Duty Commercial)

For commercial vessels with semi planing or displacement hulls in cyclical operation.

Full power could be utilized max 4 h per 12 h operation period.

Between full load operation periods, engine speed should be reduced at least 10 % from the obtained full load engine speed.

RATING 3

(Light Duty Commercial)

For commercial vessels or craft with high demands on speed and acceleration, planing or semi-planing hulls in cyclical operation. Full power could be utilized maximum 2 h per 12 h operation period.

Between full load periods, engine speed should be reduced at least 10% from the obtained full load engine speed.

RATING 4

(Special Light Duty Commercial)

For light planing craft in commercial operation. Recommended speed at cruising = 25 knots. Full power could be utilized max 1 h per 12 h operation period. Between full load operation periods, engine speed should be reduced at least 10% from the obtained full load engine speed.

RATING 5

This power is intended for pleasure craft applications, and can be used for high speed planing craft in commercial applications with special limited warranty, see warranty and service book.

Marine Genset/Auxiliary

PRIME POWER 50 HZ 1500 RPM

(Genset and Auxiliary engines with constant speed ratings) Prime Power: ratings corresponding to ISO Standard Power for continuous operation. This relates to the supplying of electrical power at variable load with 70% load factor for an unlimited number of hours. A 10% overload capability is available with this rating.

PRIME POWER 60 HZ 1800 RPM

(Genset and Auxiliary engines with constant speed ratings) Prime Power: ratings corresponding to ISO Standard Power for continuous operation. This relates to the supplying of electrical power at variable load with 70% load factor for an unlimited number of hours. A 10% overload capability is available with this rating.

MARINE GENSET FOR DIESEL ELECTRIC PROPULSION

Application type: Vessels operating with marine gensets for power to electric propulsion systems. Engine can be run for an unlimited number of running hours at a load factor of < 80%. 10% overload capability is available for maximum of 1 hour per 12 hours operation for this rating. Ratings corresponding to ISO Standard Power for continuous operation.



OPTIONS

Combine the high-performing engines with Volvo Penta's range of smart features and you will have all that you need for an outstanding working experience. Your daily job quality improves and your performances increase.



Interceptor System (IS)
You don't need to know anything about trimming. The Interceptor System is integrated in the EVC platform which makes it extremely easy to handle; just push the trim assist button on the top-mount control. With the optional Automatic mode, trimming is fully automatic.



Single-lever Mode
Lets you operate shift and throttle for twin engines with only one lever for easy and precise control over the boat speed. Very comfortable and safe when driving in rough seas.



Low-speed Mode
With the low-speed mode for Volvo Penta IPS and shaft installations you reduce boat speed at idling by 50% – from 5–6 knots to 2–3 knots. Perfect when you're driving in marinas and canals. Total system integration gives seamless operation with the standard controls.



Glass Cockpit System
The Volvo Penta Glass Cockpit System is an all-integrated control and monitoring system that gathers all driver information including warnings and alarms and displays it on a fixed point in the boat; on one or more, high-tech displays.





Trip Computer Software

Get advanced trip computer functions in your boat – just like in your car. Information about trip distance, average speed, instant fuel consumption, distance to empty, trip time and much more will help you plan your driving.



Cruise Control

With fingertip control of your engine rpm, you can fine-tune your boat's speed for best possible fuel economy and comfort. Located on the control, the Cruise Control button is easy to reach.



ACCESSORIES

Volvo Penta accessories and parts are designed, developed and manufactured to the same quality level as the Volvo Penta engines. That means high-quality products with a warranty, where each component is original and made to match. With Genuine Parts and Accessories, every Volvo Penta product will maintain highest quality standard.



Driving and maneuvering



Instrumentation



Engine accessories



Onboard comfort



Safety



DRIVING AND MANEUVERING

It's all about the handling. All Volvo Penta controls are ergonomic with a solid feel – all to make maneuvering as exact as possible to provide comfort while maintaining the highest safety.



Joysticks



EVC
controls



Steering



Trim
systems



JOYSTICK

Volvo Penta Joysticks make driving and docking easier than ever. With exact maneuvering docking will be faster and safer.



Joystick for Volvo Penta IPS

With the optional joystick for Volvo Penta IPS-powered boats, slow-speed driving and docking in confined areas have never been easier. Move your boat sideways, diagonally, forward, or rotate – with just one hand. Up to four joysticks are possible.



Joystick for Aquamatic

With the optional joystick for boats with twin Volvo Penta Aquamatic, slow-speed driving and docking in confined areas have never been easier. Move your boat sideways, diagonally, forward, or rotate – with just one hand. Up to four joysticks are possible.



EVC CONTROLS

The line-up of EVC controls features something for every taste. All features are chosen and designed to offer the best level of safety and comfort.



Volvo Penta IPS and Inboard, twin installation

The top-mounted control for Volvo Penta IPS and Inboard twin installations offers a distinctive exterior, but above all, a number of very tangible benefits. Useful features have been built into the control, which means that EVC functions are now activated and adjusted via the easily accessible buttons on the control. The result is increased comfort, better drivability and enhanced safety.



Inboard, single installation

The top-mounted control for Inboard single installations offers a distinctive exterior, but above all, a number of very tangible benefits. Useful features have been built into the control, which means that EVC functions are now activated and adjusted via the easily accessible buttons on the control. The result is increased comfort, better drivability and enhanced safety.



Inboard, side-mounted, single installation

With its unique design, the side-mounted control for single inboard installations stands out in Volvo Penta's range of controls for electronic shift and throttle. It combines precise action with an ergonomic and solid feel.





Aquamatic, twin installation

The top-mounted control for Aquamatic twin installations offers a distinctive exterior, but above all, a number of very tangible benefits. Useful features have been built into the control, which means that EVC functions are now activated and adjusted via the easily accessible buttons on the control and, for powertrim, on the lever. The result is increased comfort, better drivability and enhanced safety.



Aquamatic, single installation

The top-mounted control for Aquamatic single installations offers a distinctive exterior, but above all, a number of very tangible benefits. Useful features have been built into the control, which means that EVC functions are now activated and adjusted via the easily accessible buttons on the control and, for powertrim, on the lever. The result is increased comfort, better drivability and enhanced safety.



Aquamatic, side-mounted, single installation

The side-mounted control for Aquamatic single installations offers a distinctive exterior, but above all, a number of very tangible benefits. Useful features have been built into the control, which means that EVC functions are now activated and adjusted via easily accessible buttons on the control and, for powertrim, on the lever. The result is increased comfort, better drivability and enhanced safety.



STEERING

Volvo Penta offers a wide range of electronic, hydraulic and mechanical steering systems. Our steering wheels combine high-quality materials with a design that is perfectly matched to Volvo Penta's range of EVC controls and displays.



Electronic steering for Aquamatic

Electronic steering for Aquamatic gives smooth, effortless and very precise steering. Together with the electronic controls for shift and throttle, it forms a complete "Drive by wire-system" that represents the latest in boating technology.



Hydraulic steering system

The strength required to steer a boat equipped with a hydraulic steering system is inversely proportional to the number of turns of the wheel lock-to-lock. The wheel turns are determined by the ratio between the cylinder volume, the pump displacement and the free movement of the steering device, e.g. the rudder.



Mechanical steering system

This reliable mechanical steering system meets most inboard demands. It includes steering wheel adjustability and no-feedback functions, so the steering is not affected by external forces like waves and currents.





3-spoke leather steering wheel

A really exclusive steering wheel that is designed to match the EVC controls. It is recommended for cabin/indoor use. Leather and stainless steel (304). Diameter 350 mm.



Sport mahogany steering wheel

Exclusive design characterizes this sporty mahogany steering wheel. It is recommended for cabin/indoor use. Diameter 340 mm.



5-spoke stainless steel steering wheel

Made from high-quality 316 stainless steel, this robust steering wheel is recommended for open/flybridge use. Diameter 370 mm.



Classic mahogany steering wheel

This classic steering-wheel design fits most interiors, but is also a perfect match to the EVC controls. Exclusive mahogany and stainless steel (316). It is recommended for cabin/indoor use. Diameter 350 mm.



TRIM SYSTEM

The Interceptor System (IS) is a trim system with its origin in large, commercial vessel applications. Its robust and compact design ensures reliable performance in all conditions. Blade sizes: 600, 750, 900 and 1050 mm.

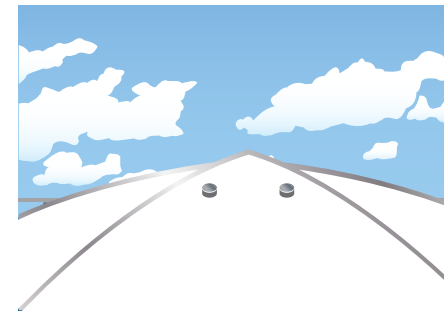

Without Interceptor System

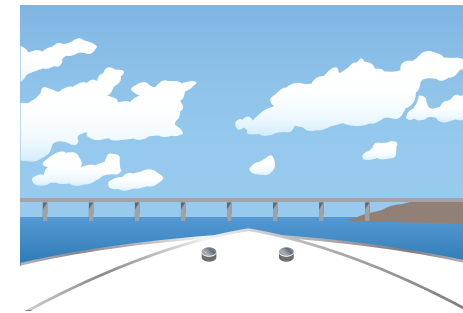

With Interceptor System

The IS provides excellent visibility for the driver during acceleration and in sharp turns which significantly enhances on-board safety. And you don't have to know anything about trimming.

The interceptor system is integrated in the EVC platform which makes it extremely easy to handle; just push the Trim assist button on the engine control. This activates

automatic mode, and your boat's trim is always optimized thanks to the advanced control system. If you prefer to trim manually, you just use the trim buttons on the control. This is easy boating at its best.

True turn for better comfort

In automatic mode, when turning, the trim system compensates so that the boat does not lean as much as

without auto or trim. This "true turn" provides better visibility and comfort.

Increased visibility

When accelerating with IS (in auto mode), the system will lift the stern and lower the bow. This means quicker onto the plane and greatly increased forward visibility during the acceleration phase. Also when you turn, your visibility to the sides is largely improved.

Note! IS cannot be used for single installations. IS auto mode requires electronic steering.



INSTRUMENTATION

Volvo Penta instruments are developed exclusively for the EVC system – a guarantee for accurate readings and high reliability – day and night, thanks to double glazing and sophisticated lighting.



Engine monitoring displays



Button panels



Options



Information gauges



ENGINE MONITORING DISPLAYS

Volvo Penta engine monitoring displays provide direct access to essential engine and boat data in one place. The information presentation can easily be adapted to suit each user.



7" color display

The 7" color display is a natural part of modern boat instrumentation. It can show data from up to three engines, trip computer information and also has a video input. You can have cameras in the engine room or for better stern visibility, etc. Intuitive navigation and the "My View" option make it very easy to customize information. The 7" display is also available as an extended alarm handling display and steering gear display (IPS only) for classified installations



2.5" display

The 2.5" black and white display has easy push-button navigation and can show a number of different data from one engine, including optional trip computer information. Intuitive navigation and the "My View" option make it very easy to customize information. Optional sensors can provide more data.





4" color display

The 4" full-color display is easy to read with custom screens. It shows all available information for one or two engines and you get the information you choose in one, easy-to-read screen.

Essential information like fuel economy, distance and time to empty, plus fuel level can all be shown – have it your way in the easily adaptable "My view".



BUTTON PANELS

With different setups for various EVC functions, these flexible control panels are available as complementary controls.



Button panels

The Button panels are used for activating and adjusting EVC functions. This flexible display panel is generic and is therefore configured during the installation to show specific buttons needed for optimal usability and functionality. The Button panel is a natural complement to controls without built-in control buttons. The display is clear and easy-to-understand and its compact size makes it easy to place.



INFORMATION GAUGES

A complete range of gauges built to marine standards with an anti-fogging membrane and full backlighting. With EVC, precision and reliability are exceptional – and installation is easy thanks to serial connections.



Different combinations

With Volvo Penta instruments, you can find a combination of display and outer rings that will suit your style. Black and white displays, and black and chrome-plated rings give you four alternatives. All instruments are available for metric and imperial units. Thanks to EVC, installation with serial connectors is easy. Available for top and flush mounting.





Tachometer

The tachometer with info display gives continuous readings of rpm and engine hours, warnings and alarms for voltage, coolant temperature, etc. – with audible signals.



Turbo pressure

Instrument for displaying turbo pressure. For turbo engines. Size: 52 mm diameter.



4-in-1 instrument

Perfect for sport boats and on the flybridge. Shows fuel level, coolant temperature, battery voltage and oil pressure for inboard engines, or trim position for Aquamatic. Size: 110 mm diameter.



Engine oil pressure

Instrument for displaying engine oil pressure. Size: 52 mm diameter.



Speedometer

Instrument for displaying boat speed. Requires sensor or NMEA input. Sizes: 85 and 110 mm diameter.



Battery voltage

Instrument for displaying battery voltage. Size: 52 mm diameter.





Trim position – analog
Instrument for displaying boat trim position. Analog reading. Size: 52 mm diameter.



Fuel tank level
Instrument for displaying fuel tank level. Requires sensor or NMEA input. Size: 52 mm diameter.



Trim position – digital
Instrument for displaying boat trim position. Digital reading. Size: 52 mm diameter.



Water tank level
Instrument for displaying water tank level. Requires sensor or NMEA input. Size: 52 mm diameter.



Rudder position
Instrument for displaying boat rudder position. Requires sensor or NMEA input. Size: 52 mm diameter.



Coolant temperature
Instrument for displaying coolant temperature. Size: 52 mm diameter.



OPTIONS

NMEA is the standard used by all the leading suppliers of marine electronics today. In other words, a system that is compatible with all other onboard electronics. Volvo Penta also provides the VP Information Gateway, a way to integrate into the ship system with full support of our integration team available.

Volvo Penta Information Gateway

IGW is a possibility for boatbuilders who want to integrate all drive line information and alarm handling into a ship system. The IGW will also transmit all data from the engine and steering system that is needed to interface a Voyage Data Recorder. Volvo Penta's integration support team will ensure that all connections are established.



NMEA 2000 interface

The interface transmit and receive various engine data over the NMEA protocol e.g. rpm, engine hours, battery voltage, coolant temperature and is used for integration of NMEA compatible equipment.



ENGINE ACCESSORIES

Every accessory is a part in a system. They are all designed and developed to work together. All accessories fulfill our tough demands of durability and reliability. They are tailor made for designed for easy mounting to engine and drive, eliminating complicated adaptations and tested as carefully as the engine.



Propellers



Fuel system



Lubrication
and cooling



Electrical supply
and power
take-off



Cooling and
exhaust systems

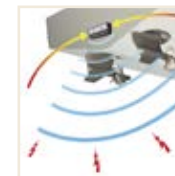

Corrosion
protection

PROPELLERS

Volvo Penta is a world-leader in propeller design. Each propeller is developed together with the specific drive and engine series. The design is unique and gives high efficiency at all speeds, safe handling and excellent onboard comfort, as well as a long service life.



Propellers for
Volvo Penta IPS



Propellers for
Aquamatic
sterndrive



PROPELLERS FOR VOLVO PENTA IPS

Unique pulling propellers with a patented design. These twin, counter-rotating propellers are made of a specially developed nickel-bronze-aluminum alloy.

Based on the Duoprop concept, they contribute great handling, maneuverability and performance to the Volvo Penta IPS propulsion system.



Type T for up to 243 kW

The T series is for Volvo Penta IPS units with a power output of up to 243 kW (IPS400MC-450).



Type TS for up to 243 kW

The T series is for Volvo Penta IPS units with a power output of up to 243 kW (IPS400MC-450). The TS type is specially designed for semi-planing boats.



Type P for 375 to 460 kW

The P series is for the mid-range Volvo Penta IPS units with power outputs from 375 to 460 kW (IPS650-800).



Type PS for 375 to 460 kW

The P series is for the mid-range Volvo Penta IPS units with a power output of 375 to 460 kW (IPS650-800). The PS type is specially designed for semi-planing boats.





Type Q for over 515-588 kW

The Q series is for the largest Volvo Penta IPS units with power outputs over from 515-588 kW (IPS900-1050).



Type QS for 515-588 kW

The Q series is for the largest Volvo Penta IPS units with power outputs 515-588 kW (IPS900-1050). The QS type is specially designed for semi-planing boats.



Line Cutter

The Volvo Penta line cutter is an easy-to-install accessory that provides additional protection in waters where it may be required. It is designed to cut through ropes, fishing lines, plastic bags and nets before they can enter between the propellers and possibly cause damage to the propeller shaft sealing. The line cutter is available for all Volvo Penta IPS models.



PROPELLERS FOR AQUAMATIC STERNDRIVE

The Duoprop, with twin, counter-rotating propellers and patented blade design – give perfect handling, easy maneuvering, excellent grip and long drive-train life.

The single propellers are made of aluminum or high-performance stainless steel and are available for right- and left-hand rotation.



Duoprop type IH

The IH-series is the aluminum option for the DPS-B drive. The patented blade geometry with thinner and bigger blades gives improved performance regarding acceleration, top speed and propeller grip. It also provides excellent cavitation resistance. An improved, 4-layer surface treatment helps protect against corrosion.

IMPORTANT! IH propellers are only approved on D3 applications below 38 knots (45 mph).



Duoprop type G

The 3-blade front and 4-blade rear propeller combination of the type G Duoprop propeller is the key to its tremendous grip in the water. The special nickel-bronze-aluminum alloy also ensures less growth and excellent corrosion resistance. For the DPS-H drive.



Duoprop type FH

The type FH stainless steel Duoprop propeller is designed for high-performance with a DPS. The material used gives the propeller blades greater torsion strength and is more resistant to cavitation damage. For the DPS-B drive.



FUEL SYSTEM

The supply of clean fuel to the engine is essential for marine safety and for avoiding mechanical breakdowns. Volvo Penta's fuel system is hassle-free and reliable.



Fuel filters

The Volvo Penta fuel filters/water separators for all Volvo Penta diesel and gasoline engines remove water and particles efficiently. They are easy to inspect and the element is convenient to replace.



Water-in-fuel sensor

For the D3-D6 engines there is a possibility to further raise the onboard safety by using the EVC compatible Water-in-fuel sensor for the Volvo Penta Pre-Fuel filter/Water separators. To get an early warning of having water in the fuel tank, the best position for a water sensor is in the Pre-Fuel Filter/Water separator between the tank and the engine. Also available in a stand-alone version.



Fuel line components

Volvo Penta offers a complete range of fuel line components, from the engine pipes, hoses, valves and fittings – all you need for safe and approved installation.



LUBRICATION AND COOLING

Volvo Penta oils and coolants are adapted to the special demands of low-emission engines. Tested to meet all requirements, they extend the life of the engine and improve onboard safety.



Coolant

Volvo Penta coolant gives vastly superior corrosion protection with special additives for aluminum protection. It is suitable for both gasoline and diesel engines. It also has good anti-freeze properties.



Gasoline engine oil

Multigrade oil for use all the year round. The oil combats sludge build-up and gives excellent protection against wear. Also suitable for catalytic engines.



Diesel engine oil

Multigrade oil for use all the year round. Complies with VDS-2 and VDS-3; tested to Volvo's highest specification for purity and protection against wear.



Synthetic gasoline engine oil

Fully synthetic oil for use all the year round. Specially developed for high performance engines. Provides excellent protection against wear under severe running conditions at both high and low temperature extremes.





Transmission oil, SAE 80W-90
Lubrication properties protect drive and transmission. Also provides excellent corrosion protection and withstands high temperatures without breaking down.



Hydraulic oil
Protects against wear and corrosion at high and low temperatures. Particularly suitable for marine use. Does not affect seal materials.



Synthetic transmission oil, SAE75W-90 & SAE75W-140
Fully synthetic oil for drives and transmissions. Because the oil is synthetic, it provides excellent protection against wear at both high and low temperature extremes and can tolerate high loads without wear.

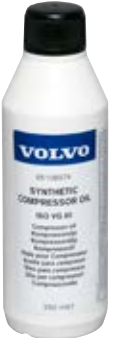

Synthetic compressor oil
Specially tested in Volvo Penta compressors. Fully synthetic oil that withstands both high and low temperatures. Protects compressor against corrosion.



ATF oil
Protects against wear at both high and low temperatures.



Oil absorbent pads
The versatile oil absorbent pads are very useful for service and maintenance and can be used for all engine- and drive-related spills and leaks. Place the pad underneath the engine or use it to wipe off the bilge after the work is done.



**Bilge absorbent booms**

The oil boom is designed to be placed in the bilge of the boat. It is easy to use and gives you better comfort on board as well as a cleaner environment. Simply drop and anchor the oil boom in the bilge and it will efficiently absorb waste oil in the bilge.



ELECTRICAL SUPPLY AND POWER TAKE-OFF

An extra alternator and an efficient distributor greatly increase the onboard power supply. With the power take-off, the engine can power e.g. a cooling compressor and a hydraulic pump.



Extra alternator

For extra electrical power or a power take-off, there are ready-to-use solutions. An extra alternator and an efficient distributor greatly increase your onboard power supply. It can power a cooling compressor, hydraulic pump etc.

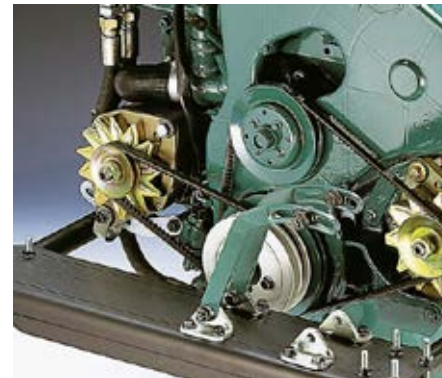

Power take-off

Front-mount bracket kit for allowing efficient power take-off. Makes it possible to install and operate extra equipment such as cooling compressors, hydraulic pumps etc.



Charging distributor

Specially adapted for Volvo Penta's alternators. Two battery circuits can be charged at the same time. The starter motor battery will always be charged, even when onboard power consumption has been high and the second battery is flat.



COOLING AND EXHAUST SYSTEMS

Volvo Penta offers complete systems with silencers, hoses, elbows and everything else needed – all perfectly in tune with the respective engine series.

Silencers

The silencer effectively silences engine exhaust noise with a minimum of back pressure. The silencer also functions as an effective water-lock.



Elbow couplings

The elbow coupling for use in wet exhaust systems is simple to install and reduces the risk of a kink forming in the exhaust hose. Material: Stainless steel with preformed collar for hose connection.



Cooling water intake

The cooling system is an extremely important part of the engine assembly. With the right cooling water intake, overheating of the engine, unnecessary stoppages and expensive repairs due to engine failure, can be avoided.



Freshwater cooling kit

The freshwater cooling kits are designed to modify seawater-cooled engines for use with freshwater cooling. Freshwater cooling reduces internal corrosion and enables the engine to maintain a consistent and optimal working temperature under all conditions. Freshwater cooling is standard for all Volvo Penta diesel engines and available for the Volvo Penta gasoline engines. The freshwater cooling kits are Genuine Volvo Penta Parts – developed and manufactured by Volvo Penta.





Seawater filter, heavy duty

This seawater filter is a high-capacity filter for use in contaminated waters or where additional safety is called for. If needed, the filter is easy to open and clean, which ensures a safer boat trip. The transparent lid makes it easy to inspect.



Upgrade kit for Seawater filter, heavy duty

This upgrade kit features a transparent lid which makes inspection of the filter easier. The kit fits all D4/D6 with a solid lid.



Anti-siphon valve

For boats with engines installed level with, or below, the waterline, it is important that the cooling system is fitted with an anti-siphon valve to prevent water from entering the boat. Volvo Penta's anti-siphon valve is efficient, easy to install, and requires very little maintenance.



Cooling hoses

Volvo Penta rubber hoses are specifically designed for use with the engine's cooling system and are manufactured to withstand both suction and pressure.



Fuel hoses

Fuel hose, fire resistant in accordance with ISO7840-A1 and J1527 USCG type 2. Internal diameter 3/8". Supplied per meter. Recommended stainless steel hose clips, part no. 961664. The product fulfills the requirements of Recreational Craft Directive 94/25/EC.



Exhaust hoses

A flexible exhaust hose for marine wet exhaust systems that conforms with ISO13363 type 2 (+580°C) and SAE J 2006 type R2. Its bend radius means easy and quick installation. Reinforced by synthetic textile layers and embedded steel wire helix it has plain and smooth inner surface for minimum exhaust back pressure and a smooth outer surface.



CORROSION PROTECTION

Protecting the boat's drive system – both externally and internally – is easy thanks to Volvo Penta's corrosion protection systems.

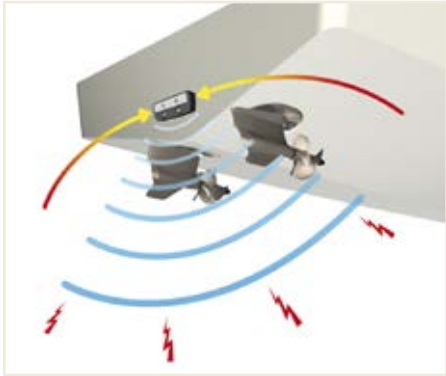

Active Corrosion Protection for Volvo Penta IPS

The ACP system offers highly efficient corrosion protection for Volvo Penta IPS installations. As a boat owner, you need not worry about insufficient protection or frequent maintenance of sacrificial anodes.

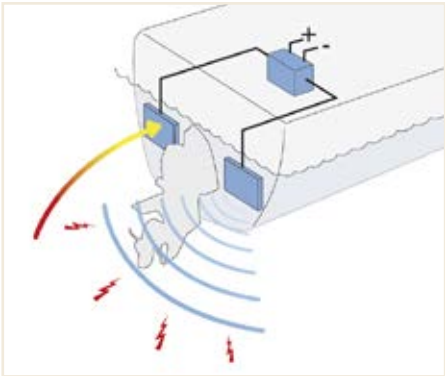

Active Corrosion Protection for SX/DPS drives

The Volvo Penta Active Corrosion Protection helps prevent galvanic corrosion from attacking the metal parts of your sterndrive. The easy-to-install ACP system complements the sacrificial anodes.



Neutra-Salt engine flushing system

Flush the engine while the boat is in the water. Saltwater boats are continuously challenged by the corrosive effects of salt. With Volvo Penta Neutra-Salt engine flushing system you get an effective and simple remedy for internal corrosion and help extend the life of your engine.



ONBOARD COMFORT

A dry, warm and quiet cabin makes the boat trip more enjoyable and comfortable.



Air heater

Perfectly integrated with your engine, the air heater utilizes the excess engine heat and converts it into heated air which is distributed in the cabin. It makes the cabin warm and dry and serves as a defroster for the windshield.



Sound absorbent

Highly efficient sound-absorbent panels made of recycled plastic foam are protected by a flame- and oil-resistant aluminum foil. Easy to cut to shape. Available as self-adhesive or non-adhesive sheets (500 x 1,000 mm panels) in thicknesses of 20, 30 and 50 mm. Aluminum tape and sound insulation hangers are accessories for convenient mounting.



SAFETY

Safety at sea is very much a matter of being prepared, e.g. with one of Volvo Penta's efficient bilge pumps.



Electrical bilge pumps

An electrical bilge pump increases safety and comfort onboard. The wide range of Volvo Penta bilge pumps can handle most bilge pumping situations and are extremely economical with electrical power.



Manual bilge pumps

For safety reasons, you should always install a manual bilge pump onboard. If your boat runs out of power, you can still pump up to 90 l/min by hand. The pumps come in two versions; for installation through the deck or behind a bulkhead.



Belt guard

The belt guard provides a shield for the belt that drives the water pump and standard alternator, thus improving safety on board.



Safety lanyard

The safety lanyard stops the engine if the driver should fall overboard. It is an important accessory onboard all fast boats. You should always carry a spare!



PARTS AND SERVICE

With more than 100 years of experience working with marine professionals, Volvo Penta has the heritage and knowledge necessary to support your engine throughout its entire lifecycle.

You have the reassurance of the Volvo Penta dealer network, the backing of the Volvo Group's extensive parts distribution system — designed to maximize your productivity and availability and protect your investment. Your dealer can tailor service and support to fit your needs.

Volvo Penta and our dealer network work alongside you, enabling you to focus on your core business.

Global dealer network

The Volvo Penta marine commercial dealer network, is constantly being developed to meet your local needs.

Parts

Designed, manufactured and tested for optimum performance, reliability and long service life with a world-class distribution network.

Service & Support

Utilizing the wide range of Volvo Penta service and support will help you maximize productivity and the value of your investment.

Extended coverage

Maximize uptime, and minimize unexpected repair costs with the Extended Coverage program.



Global dealer network, local expertise

The Volvo Penta marine commercial dealer network, with close to 700 authorized dealers worldwide, is constantly being developed to meet your needs and secure the local expertise necessary to keep your business going.

Our marine commercial dealers are trained in the latest Volvo Penta technology and repair processes and are required to comply with our marine commercial dealer operating standard, which is designed to ensure consistently high-quality service and support. Aligned with Volvo Penta's core values of quality, safety and environmental care, the dealer operating standard focuses on:

- Technical competence, including advanced diagnostics
- 24/7 accessibility
- Field service support
- Excellent parts availability
- Speedy repairs and quick response to customer questions

To secure the best possible service and support, we provide our marine commercial dealers with continuous product training, as well as regular competence assessments to secure to ensure your local dealer is fully equipped to help you maximize your productivity, as well as the value of your investment.



PARTS

Your Volvo Penta engine is engineered and built to meet the highest standards of quality in every detail, with all parts designed to work together perfectly for optimum performance, reliability and a long service life. And that also goes for Genuine Volvo Penta Parts, which are manufactured to the same rigorous specifications as the factory-fitted parts comprising your engine.

Genuine Volvo Penta Parts — including remanufactured exchange components and repair and overhaul kits — allow you to choose the best solution for your engine without compromising on quality.



Genuine Volvo
Penta Parts



Exchange
components



Repair &
Overhaul Kits



Parts
Distribution
Network



Genuine Volvo Penta Parts – engineered to perform

Get the most out of your engine with Genuine Volvo Penta Parts, which are designed, manufactured and tested for optimum performance, reliability and long service life.

Their precise fit ensures all components in your engine work together perfectly for safe and reliable functionality. With the right parts built to the right specifications, the engine's fuel efficiency is maintained to keep fuel costs and emissions down.

All in all, Genuine Volvo Penta Parts are the best protection for your engine and vital for maximum productivity and long-term value.

The benefits of Genuine Volvo Penta Parts:

- Optimum performance, reliability and service life
- All components work together perfectly
- Engineered to the exact specifications and tolerances of your engine
- Maintain optimal fuel-efficiency to minimize fuel costs and emissions
- Covered by Volvo Penta 12-month standard warranty, or 24 months when fitted by an authorized Volvo Penta dealer
- Perfect fit ensures quicker service, as well as safe and reliable functionality
- Up to date with the latest design changes

Your local Volvo Penta dealer – backed by our efficient global parts distribution – will make sure you get the right parts at the right time.



Exchange components – genuine performance, lower cost

The Volvo Penta Exchange system gives you access to a comprehensive range of remanufactured components — from injectors and turbos to longblocks and IPS drive units — offering a cost-effective alternative to repair and overhaul.

All components, are completely restored to new condition and meet the same stringent quality and safety requirements as new parts. Exchange components are kept current with technical design changes and are offered with the same warranty as new Genuine Volvo Penta Parts.

With Volvo Penta Exchange components, you're assured of a perfect fit and quick exchange, as well as reduced ownership and operating costs — without compromising on quality, durability and performance

The benefits of Volvo Penta Exchange components:

- Genuine performance and efficiency at a lower cost
- Quick exchange, less downtime
- Same quality and warranty as new Genuine Volvo Penta Parts
- Cost-effective alternative to repair and overhaul
- Less impact on the environment through recycling
- Lower ownership and operating costs
- Up to date with the latest design changes

With the flexible core return program, you can return worn components once the new component is installed and the engine is running again.



Repair & Overhaul Kits – all the benefits, just one package

Volvo Penta repair and overhaul kits, containing only Genuine Volvo Penta Parts, are offered at a lower price than buying each part separately.

All kits are carefully designed and include the parts you need for repair and overhaul. This means you won't have to spend time identifying and ordering each part separately — and in addition, the work can be done smoothly without delays caused by a missing part.

The benefits of Volvo Penta repair and overhaul kits

- Save time and money without compromising on quality
- Easy to order, all the parts you need in one package
- Exclusively Genuine Volvo Penta Parts
- Pre-packed kits for fast delivery
- Up to date with the latest design changes
- Perfect fit for easier assembly
- Covered by Volvo Penta 12-month standard warranty, or 24 months when fitted by an authorized Volvo Penta dealer



Available Repair & Overhaul Kits

Overhaul kits - Engine
Contains cylinder liner kits, all crank bearings and all engine gaskets

Overhaul kits - Cylinder head
Contains valve, guides, seats, collets, injector sleeves. For pushrod engines, also contains valve tappets.

Cylinder liner kit
Contains cylinder liner, piston, piston rings and o-rings

Gasket kits
Available for cylinder head, manifold, turbo connection, engine reconditioning and decarbonizing.

Parts Distribution Network – the right parts at the right time

Volvo Penta benefits from Volvo Group Logistic Services, one of the most efficient global parts distribution networks in the industry.

It provides the entire Volvo Penta dealer network with world-class supply chain and logistic services — ensuring you get the right parts at the right place at the right time.

The logistic services provided include:

- Efficient and sustainable transport solutions
- 17 warehouses located strategically around the world
- Global 24/7 online ordering
- Inventory management with automatic dealer stock refill
- Help desk support and tracking systems
- Segmented stocking for 8,000 uptime-critical parts

In addition, if an urgently needed part isn't available over the counter, the emergency delivery service and its support team will make sure that the right parts are quickly on hand to secure maximum uptime and availability.



Volvo Penta warehouse locations

- CENTRAL WAREHOUSE
BYHALIA
GENT
- SUPPORT WAREHOUSE
BOLONGA
GÖTEBORG
LYON
- MADRID RUGBY REGIONAL WAREHOUSE
BANGALORE
CURITUBA
ISTANBUL
JOHANNESBURG
MINTO
MOSCOW
SHANGHAI
SINGAPORE
TOKYO
VANCOUVER



SERVICE & SUPPORT

Volvo Penta's marine commercial dealers offer the technical expertise and high quality parts required to ensure optimum performance and fuel efficiency over your engine's lifetime. Utilizing the wide range of Volvo Penta service and support will help you maximize productivity and the value of your investment.

Dealer workshops are equipped with advanced diagnostics systems, the full range of special tools and the very latest service information. Maintenance and repairs are carried out by highly skilled technicians, who are continuously trained in the latest Volvo Penta technology and repair methods and who use only Genuine Volvo Penta Parts.



Service
agreements



Oil analysis



Volvo Penta
Action Service



Quickline



Service agreements - focus on your core business

Volvo Penta service agreements are designed to help you maximize uptime, lower total cost of ownership and improve cost control — giving you more time to focus on your core business.

A Volvo Penta service agreement is between you and your Volvo Penta dealer. It can be tailored to your operating needs and budget to include anything from regular inspections to a comprehensive service and maintenance program that includes preventive repairs.

The benefits of Volvo Penta service agreements:

- Optimized uptime and easy ownership
- Predictable costs, simplified budgeting
- Tailored to your operating needs and budget
- Lower total cost of ownership
- More time to focus on your core business



Oil analysis – for better control

Volvo Penta oil analysis delivers a comprehensive diagnosis of the engine's condition. Oil analysis provides information such as water and fuel content, viscosity, dirt, and the amount of metal particles in the oil from component wear.

Thanks to early warnings provided by oil analysis, you can plan preventive maintenance and component changes, thus reducing repair costs and ultimately helping you increase productivity.

The benefits of regular Volvo Penta oil analysis:

- Comprehensive diagnosis of the engine's condition
- Makes trends visible and provides early warnings for abnormal wear
- Increased uptime and reduced operating costs
- Excellent planning tool for preventive maintenance
- High-quality analysis done by accredited laboratories using specified limits values defined by Volvo Penta



Volvo Penta Action Service

If you experience a breakdown, Volvo Penta Action Service offers assistance 24 hours a day, every day of the year.

An Action Service operator is on hand to help 24 hours a day, 7 days a week, backed by the assistance of our dealer network. The operator will support you all the way through your case. If assistance or technical support is needed, the operator will put you in contact with the closest Volvo Penta dealer with the right competence.

The service is available throughout Europe (in 19 languages), North America and China (including Hong Kong).

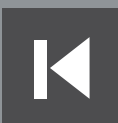

Quickline – custom-built on short notice

In the event of a serious engine breakdown, Volvo Penta Quickline provide one more way of helping you get up and running again - Regardless of the make of engine you need to replace.

In just seven days, Volvo Penta can produce custom-built, classified and non-classified 300 to 750 hp D9MH, D13MH or D16MH propulsion engines since the factory is authorized for full approval by main classification societies.

Volvo Penta uses base engines kept in stock for the Quickline at the plant. These will be custom-built to match your specific needs.

The benefits of Volvo Penta Quickline

- 300 to 750 hp propulsion engines
- Custom built to match your specific needs
- Classification according to DNV, RINA, LRS, ABS and BV possible
- Ready for delivery within 7 days
- Downtime reduced to a minimum



Extended coverage

Full coverage

The program includes the same full coverage as in the standard first year warranty for up to four additional years. It covers repair and replacement of defective parts, including all Volvo Penta branded products, but excluding consumables.

The Extended Coverage program can be purchased when the engine is ordered or within three months of the date of warranty registration.

Maximize uptime, and minimize unexpected repair costs with the Extended Coverage program.

- Available worldwide for all Volvo Penta-branded marine commercial diesel engines
- Can be purchased when the engine is ordered or up to three months from the date of warranty registration

Prerequisites

- Applies only to products in commercial use
- Regular service and maintenance according to applicable service schedule
- Complete commissioning report
- Terms & conditions apply



WANT TO KNOW MORE?

Contact your Volvo Penta representative or go to www.volvopenta.com where you will find up-to-date and complete product information, plus these services:

Dealer locator

The easiest way to find our dealers and importers all over the world.

Web catalog

All genuine Volvo Penta parts and accessories.

Repowering information

The “Engine configurator” guides you to the engine best suited for you. The “Repowering guide” can be downloaded.

Operator’s manuals

For most Volvo Penta engines, free download.

Propeller guide

Correct propeller choice to optimize performance and fuel economy.

Product brochures

Engine range, High Performance propulsion and Heavy Duty brochures available for download.

The screenshot displays the Volvo Penta website interface. At the top, the 'VOLVO PENTA' logo is visible on the right. Below the logo, there are three large images of Volvo Penta engines. Underneath the images, there is a navigation menu with five columns: 'Global', 'W Europe', 'E Europe & Asia', 'Americas', and 'Industrial engines'. Each column contains a list of countries or regions with a small arrow icon next to each item. At the bottom of the page, there is a 'SHARE THIS' button.

Global	W Europe	E Europe & Asia	Americas	Industrial engines
<ul style="list-style-type: none"> Global site in English Volvo Penta dealer locator Volvo Group 	<ul style="list-style-type: none"> Belarus Denmark Finland France Germany Italy Norway Spain Sweden United Kingdom 	<ul style="list-style-type: none"> Albania Austria Bosnia Herzegovina Belarus China Croatia Czech Republic Hungary Japan Kazakhstan Macedonia Moldova Montenegro Poland Romania Russia Serbia Singapore Slovenia Slovakia Turkey Ukraine 	<ul style="list-style-type: none"> Brazil North America 	<ul style="list-style-type: none"> Chinese English