

Inboard Propeller Catalog





Contents.

- Pg. 4: About Us**
- Pg. 6: Locations**
- Pg. 8: Manufacturing Processes**
- Pg. 10: Recreational Propellers**
 - Pg. 12-13: “X” Series Propellers
 - Pg. 14-15: Dyna Series Propellers
 - Pg. 16-17: HyTorq Propellers
 - Pg. 18-19: Sailboat Propellers
 - Pg. 20-21: “M” Series Propellers
 - Pg. 22: “CX” Series Propellers
 - Pg. 23: Design Considerations
 - Pg. 24: Marlin Series Propellers
- Pg. 26: Commercial Propellers**
 - Pg. 28-29: Work Horse & Machine Pitch Propellers
 - Pg. 30-31: DQ Special / Dura Quad / Pac-Master
 - Pg. 32-33: Kaplan Propellers & Nozzles
 - Pg. 34-35: Weedless Propellers
 - Pg. 36: Nakashima Propellers - CPP/FPP
 - Pg. 37: Nakashima Bow Thrusters
- Pg. 38: Michigan Legacy Propellers**
- Pg. 40: Comprehensive Propulsion Systems**
- Pg. 42: Aqualube Bearings**
 - Pg. 42-43: Aqualube Brass Bearings
 - Pg. 44-45: Aqualube Phenolic Bearings
- Pg. 46: Hale MRI**
- Pg. 48: Company History**
- Pg. 50: Propeller Terms and Definitions**
- Pg. 52: Marine Propeller Shaft End Dimensions**
- Pg. 53: Inboard Propeller Installation Procedures**
- Pg. 54: Prop-It-Right Sizing Form**
- Pg. 55: Inboard Warranty**



About Us.

Michigan Wheel has been committed to excellence in propulsion for over 100 years. During this time Michigan Wheel has built a reputation of quality and performance by supplying recreational, commercial, and military vessels with the finest propellers available.

Being a leading global supplier of marine propulsion products requires a skilled team. Michigan Wheel's Engineering, Production, Quality, Sales, and Customer Service teams work together to supply products and services unmatched in the marine industry.

The engineering department uses the latest in CFD technology to create advanced designs. The production team uses NC milling techniques to ensure accurate hydrodynamic surfaces. The quality team uses computerized measurement recording devices to measure our products and ensure they meet our strict tolerances. Finally, Michigan Wheel's Sales and Customer Service departments work closely with our network of experienced distributors to ensure users are provided the optimal equipment for their application.

Michigan Wheel is committed to providing superior products for their customers when they are on the water for recreation, work, or in service to their country.



***“Michigan Wheel
is committed
to providing
superior
products for
their customers
when they are
on the water for
recreation, work,
or in service to
their country.”***



Locations.

American Manufacturing.
Global Influence.



UNITED STATES

World Headquarters
1501 Buchanan Ave. SW
Grand Rapids, MI 49507
P: 1-800-369-4335
F: 1-616-247-0227
W: www.miwheel.com
E: info@miwheel.com



UNITED KINGDOM

Europe Headquarters
Unit C1 B, Pottery Road
Newton Abbot, Devon
TQ12 3B2
P: +44 1626 351723
F: +44 1626 351724
W: www.mmp-i.com
E: sales@mmp-i.com



UNITED ARAB EMIRATES

Middle East - Africa - Asia HQ
P.O. Box 54805, DY-1, Show Room No. 7
Al Jadaf Ship Docking Yard
Dubai, United Arab Emirates
P: +971 4 3243867
F: +971 4 3243868
W: www.miwheel-meaa.com
E: sales@miwheel-meaa.com



Quality Manufacturing.

Control

Michigan Wheel controls every aspect of the production process to ensure the finished product is an accurate interpretation of the design. From the foundry to the shipping dock, our computerized planning systems track the part through the production process. By utilizing processes developed under ISO:9001 standards, our propellers are built with repeatable precision.



Tolerance

Michigan Wheel's manufacturing tolerances are based on the ISO-484/2 standards for marine propellers. By utilizing NC machining techniques and using the latest in propeller measurement technology, Michigan Wheel is able to build incredibly accurate propellers that meet the varied tolerance requirements of their customers.



| ABS Certification | ISO:9001





Recreational Propellers

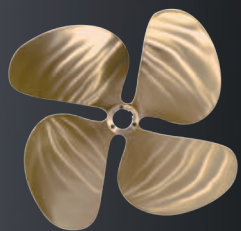

CX-400



CX-500



CX-600

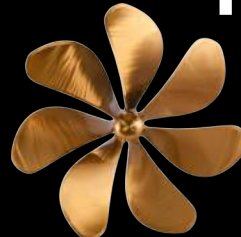

CX-700

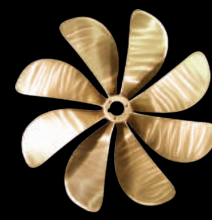

CX-800



DJ-355



DJX



DQ-486



DQ-469



DQX



Dyna-Jet



Dyna-Quad



EPY



EQY



M-500



Marlin



MY-T3



MY-T4



MY-T5



Sailer 2



Sailer 3



“X” SERIES

Specifications

DJX	
Blades	3
E.A.R.	0.61
Diameter Range	12” - 21”
Skew	21°

DQX	
Blades	4
E.A.R.	0.735
Diameter Range	17” - 22”
Skew	21°

DQX	
Blades	4
E.A.R.	0.810
Diameter Range	23” - 32”
Skew	21°

Who Should Buy “X” Series Propellers?

The “X” Series is a high-performance line of machine finished propellers that fit a wide range of planing pleasure boats. The DJX and the DQX are evolutions of our classic Dyna-Jet and Dyna-Quad propeller designs, optimized to utilize the full power of modern engines. Designed with more efficient blade sections and increased blade area, “X” Series propellers are able to better manage cavitation and decrease vibration when compared to similar products.

Michigan Wheel uses NC machine finishing that ensures a more accurate propeller than standard hand finished propellers. This results in higher quality propellers that meet Michigan Wheel’s stringent tolerance requirements at competitive prices. The “X” Series is the standard for high quality, performance oriented propellers.



“THE ‘X’ SERIES IS THE STANDARD FOR HIGH QUALITY, PERFORMANCE-ORIENTED PROPELLERS.”

Recreational Applications

Unsure if this is the right propeller for you? Contact your local Michigan Wheel Distributor, or the Michigan Wheel team to review your application.

Excellence in Propulsion

DYNA-SERIES

Specifications

DYNA-JET	
Blades	3
E.A.R.	0.56
Diameter Range	17" - 48"
Pitch Range*	0.7 - 1.1

DYNA-QUAD	
Blades	4
E.A.R.	0.69
Diameter Range	17" - 36"
Pitch Range*	0.7 - 1.1

M-500	
Blades	5
E.A.R.	0.86
Diameter Range	24" - 46"
Pitch Range*	0.75 - 1.3

*Pitch range indicates the Pitch/Diameter ratio.

Who Should Buy "Dyna" Series Propellers?

The Dyna Series is Michigan Wheel's classic line of performance pleasure boat propellers. Available in 3, 4, and 5 blade models to cover a wide range of vessels. The Dyna Series of propellers continues to be one of Michigan Wheel's most popular series of propellers and is considered by many to be the standard in recreational propellers.

The Dyna blade design provides a great balance of performance and durability for recreational boats and is also a popular choice for higher speed commercial vessels. Dyna Series propellers are hand finished by Michigan Wheel's skilled craftsmen to ensure quality and performance that exceeds our customer's expectations.

"...ONE OF MICHIGAN WHEEL'S MOST POPULAR SERIES OF PROPELLERS, AND IS CONSIDERED BY MANY TO BE THE STANDARD IN RECREATIONAL PROPELLERS."



Recreational Applications

Unsure if this is the right propeller for you? Contact your local Michigan Wheel Distributor, or the Michigan Wheel team to review your application.

Excellence in Propulsion

DYNA-JET & DYNA-QUAD SPECIFICATIONS								DYNA-JET (0.56 E.A.R.)				DYNA-QUAD (0.69 E.A.R.)			
DIAMETER		HUB DIMENSIONS (INCHES)			STANDARD TAPER BORE (INCHES)			MAXIMUM BLADE WIDTH (INCHES)	EXPANDED AREA PER BLADE (SQ.IN)	APPROX. NET WEIGHT (LBS.)	*WR ² (LBS.-IN ²)	MAXIMUM BLADE WIDTH (INCHES)	EXPANDED AREA PER BLADE (SQ.IN)	APPROX. NET WEIGHT (LBS.)	*WR ² (LBS.-IN ²)
INCHES	MM	AFT END	FORWARD END	LENGTH	MINIMUM BORE	MAXIMUM BORE	PILOT BORE								
9	229	1-3/8	1-1/2	2-1/8	3/4	7/8	3/4	3-7/8	11.7	2.5	10	-	-	-	-
10	254	1-1/2	1-5/8	2-1/4	3/4	1	3/4	4-5/16	14.5	3	17	-	-	-	-
11	279	1-1/2	1-5/8	2-1/4	3/4	1	3/4	4-3/4	17.7	4	26	-	-	-	-
12	305	1-5/8	1-3/4	2-3/8	7/8	1-1/8	7/8	5-3/16	21.1	5	40	-	-	-	-
13	330	1-5/8	1-13/16	2-3/4	1	1-1/8	1	5-5/8	24.8	6	60	-	-	-	-
14	356	1-7/8	2	2-3/4	1	1-1/4	1	6	28.7	8	86	-	-	-	-
15	381	1-7/8	2	2-3/4	1	1-1/4	1	6-7/16	33.1	9	120	-	-	-	-
16	406	2-1/8	2-3/8	3-1/4	1-1/8	1-3/8	1-1/8	6-7/8	37.5	11	167	-	-	-	-
17	432	2-1/8	2-3/8	3-1/4	1-1/4	1-3/8	1-1/4	7-5/16	42.8	13	224	6-3/4	38.7	14	257
17**	432	2-3/8	2-5/8	3-3/4	1-1/4	1-1/2	1-1/4	7-5/16	42.8	13	224	-	-	-	-
18	457	2-3/8	2-5/8	3-3/4	1-1/4	1-1/2	1-1/4	7-3/4	47.4	16	298	7-1/8	43.2	17	341
19	483	2-3/8	2-5/8	3-3/4	1-1/4	1-1/2	1-1/4	8-3/16	53.1	18	388	7-1/2	48.3	20	445
20	508	2-3/8	2-5/8	3-3/4	1-1/4	1-1/2	1-1/4	8-5/8	59.0	20	500	7-15/16	53.7	23	573
21	533	2-3/4	3	4-1/8	1-3/8	1-3/4	1-3/8	9-1/16	64.6	25	640	8-5/16	58.8	28	733
22	559	2-3/4	3	4-1/8	1-3/8	1-3/4	1-3/8	9-1/2	71.2	28	803	8-11/16	64.8	31	920
23	584	3	3-1/4	4-1/2	1-1/2	2	1-1/2	9-7/8	77.6	33	1,004	9-1/16	70.6	36	1,150
24	610	3	3-1/4	4-1/2	1-1/2	2	1-1/2	10-3/8	84.7	36	1,237	9-1/2	77.1	40	1,216
26	660	3-3/8	3-3/4	4-7/8	1-3/4	2-1/4	1-3/4	11-1/4	99.1	46	1,844	10-1/4	90.2	52	2,110
28	711	3-3/4	4-1/8	5-3/4	2	2-1/2	2	12-1/16	114.7	60	2,671	11-1/16	104.4	66	3,056
30	762	4-1/4	4-5/8	6	2	3	2	12-15/16	131.1	76	3,775	11-7/8	119.3	84	4,316
32	813	4-1/4	4-5/8	6	2	3	2	13-3/4	150.0	88	5,172	12-5/8	136.5	97	5,917
34	864	4-1/4	4-5/8	6-1/2	2-1/4	3	2-1/4	14-5/8	170.0	101	6,973	13-7/16	154.7	112	7,978
36	914	4-5/8	5-1/8	8	2-3/4	3-1/2	2-3/4	15-1/2	190.1	124	9,289	14-1/4	173.0	138	10,622
38	965	4-5/8	5-1/8	8	2-3/4	3-1/2	2-3/4	16-3/8	212.7	140	12,108	15	193.5	156	13,851
40	1,016	5	5-1/2	9	3	3-3/4	3	17-1/4	235.3	168	15,646	15-13/16	214.1	186	17,892
42	1,067	5-3/8	6	10-7/16	3	4	3	18-1/8	258.8	205	20,016	16-5/8	235.5	226	22,878
44	1,118	5-7/16	6-3/16	11	3	4	3	19	284.5	233	25,187	17-3/8	258.9	258	28,790
46	1,168	5-5/8	6-1/4	11-7/8	3	4	3	19-7/8	311.5	266	31,385	18-3/16	283.5	293	35,376

* WR2 = ±10% in Air (inch squared lbs.)

For Dyna-Jet M.W.R. = 0.33 B.T.F. = 0.050
 For Dyna-Quad M.W.R. = 0.33 B.T.F. = 0.047

** For Dyna-Jet Series propellers only - Sizes (Dia. x Pitch) 17x16, 17x17 & 17x18 maximum bore is 1-1/2". All other 17" diameter sizes - maximum bore is 1-3/8".

M-500 SPECIFICATIONS (0.86 E.A.R.)												
DIAMETER		HUB DIMENSIONS (INCHES)			STANDARD TAPER BORE (INCHES)			MAXIMUM BLADE WIDTH (INCHES)	EXPANDED AREA PER BLADE (SQ.IN)	APPROX. NET WEIGHT (LBS.)	*WR ² (LBS.-IN ²)	
INCHES	MM	AFT END	FORWARD END	LENGTH	MINIMUM BORE	MAXIMUM BORE	PILOT BORE					
22	559	2-3/4	3	4-1/8	1-3/8	1-3/4	1-3/8	8-11/16	64.9	37	1,150	
23	584	3	3-1/4	4-1/2	1-1/2	2	1-1/2	9-1/16	70.6	43	1,430	
24	610	3	3-1/4	4-1/2	1-1/2	2	1-1/2	9-1/2	77.1	48	1,770	
26	660	3-3/8	3-3/4	4-7/8	1-3/4	2-1/4	1-3/4	10-1/2	90.2	62	2,630	
28	711	3-3/4	4-1/8	5-3/4	2	2-1/2	2	11-1/16	104.4	79	3,810	
30	762	4-1/4	4-5/8	6	2	3	2	11-7/8	119.3	99	5,380	
32	813	4-1/4	4-5/8	6	2	3	2	12-5/8	136.5	115	7,380	
34	864	4-1/4	4-5/8	6-1/2	2-1/4	3	2-1/4	13-7/16	154.7	134	9,960	
36	914	4-5/8	5-1/8	8	2-3/4	3-1/2	2-3/4	14-1/4	173.0	164	13,250	
38	965	4-5/8	5-1/8	8	2-3/4	3-1/2	2-3/4	15	193.5	186	17,280	
40	1,016	5	5-1/2	9	3	3-3/4	3	15-7/8	214.1	221	22,320	
42	1,067	5-3/8	6	10-7/16	3	4	3	16-9/16	235.5	267	28,520	
44	1,118	5-7/16	6-3/16	11	3	4	3	17-3/8	258.9	305	35,900	
46	1,168	5-5/8	6-1/4	11-7/8	3	4	3	18-3/16	283.5	347	44,740	

* WR2 = ±10% in Air (inch squared lbs.)

M.W.R. = 0.37

B.T.F. = 0.046

HYTORQ PROPELLERS

Specifications

MY-T3	
Blades	3
E.A.R.	0.56
Diameter Range	9" - 36"
Pitch Range*	0.7 - 1.1

MY-T4	
Blades	4
E.A.R.	0.69
Diameter Range	17" - 46"
Pitch Range*	0.7 - 1.1

MY-T5	
Blades	5
E.A.R.	0.86
Diameter Range	22" - 46"
Pitch Range*	0.75 - 1.3

Who Should Buy HyTorq Series Propellers?

HyTorq propellers were originally designed for the pleasure boats and fishing vessels of the Canadian Maritime Provinces. These propellers were extremely successful and quickly became popular throughout North America among boaters and boat builders alike. HyTorq propellers come in 3, 4, and 5 blade configurations, allowing them to be a great fit for vessels of varying speeds, powers, and sizes.

Similar to our Dyna Series, our HyTorq line is a classic design well suited for a number of different recreational and commercial applications. Compared to the Dyna Series, HyTorq propellers have a slightly different blade shape and a touch thicker blade sections, making them a particularly good choice for commercial boats.



Recreational Applications

Unsure if this is the right propeller for you? Contact your local Michigan Wheel Distributor, or the Michigan Wheel team to review your application.

Excellence in Propulsion

HyTORQ SPECIFICATIONS							HyTORQ MY-T3			HyTORQ MY-T4		
PROPELLER DIAMETER	AFT HUB DIAMETER	FORWARD HUB DIAMETER	HUB LENGTH	STANDARD TAPER BORE (INCHES)			WEIGHT (LB.)**	DEVELOPED AREA (IN ²)	WR ^{2**} (LB-IN ²)	WEIGHT (LB.)**	DEVELOPED AREA (IN ²)	WR ^{2**} (LB-IN ²)
				MINIMUM BORE	MAXIMUM BORE	PILOT BORE						
17	2-1/4	2-1/2	3-1/2	1-1/4	1-1/2	1-1/4	16	126.6	333	19	153.1	366
18	2-3/8	2-5/8	3-1/2	1-1/4	1-3/4	1-1/4	17	141.9	392	19	171.7	429
19	2-3/8	2-5/8	3-7/8	1-1/4	1-3/4	1-1/4	19	166.2	478	21	202.7	499
20	2-3/8	2-5/8	4	1-1/4	1-3/4	1-1/4	21	175.3	553	23	212.1	622
21	2-3/4	3	4-1/8	1-3/8	2	1-3/8	27	202.4	680	28	238.6	790
22	2-3/4	3	4-1/4	1-3/8	2	1-3/8	30	212.1	810	31	256.9	940
23	3-1/8	3-1/4	4-1/4	1-1/2	2	1-3/8	35	240.6	1,070	39	288.4	1,300
24	3-1/8	3-1/4	4-5/8	1-1/2	2	1-3/8	35	252.4	1,220	41	305.4	1,450
26	3-3/8	3-5/8	5	1-3/4	2-1/4	1-1/2	50	296.3	1,770	53	358.4	2,150
28	3-3/4	4	5-3/4	1-3/4	2-1/2	1-3/4	57	343.6	2,630	66	415.6	3,240
30	4	4-1/4	6	1-3/4	2-3/4	1-3/4	78	394.4	3,520	82	477.1	4,230
32	4-1/4	4-1/2	6	2	3	2	94	448.8	4,810	100	542.9	5,960
34	4-1/4	4-1/2	6-1/2	2	3	2	107	506.6	6,460	140	612.8	8,020
36	4-3/4	5-1/4	8-1/4	2-3/4	3-1/2	2-1/2	130	567.7	8,910	146	686.7	11,230
38	5-1/4	5-1/2	8-1/4	2-3/4	3-1/2	2-1/2	-	-	-	172	765.2	13,750
40	5-1/4	5-1/2	9	3	3-3/4	3	-	-	-	192	847.8	17,180
42	5-1/2	6	10-1/2	3	4	3	-	-	-	240	930.2	24,400
44	5-1/2	6-1/4	10-1/2	3	4	3	-	-	-	282	1,025.8	31,500
46	5-1/2	6-1/4	10-1/2	3	4	3	-	-	-	304	1,121.0	37,000
48	5-1/2	6-1/4	10-1/2	3	4	3	-	-	-	340	1,121.0	45,800

HyTORQ SPECIFICATIONS							HyTORQ MY-T5			
PROPELLER DIAMETER	AFT HUB DIAMETER	FORWARD HUB DIAMETER	HUB LENGTH	STANDARD TAPER BORE (INCHES)			WEIGHT (LB.)**	DEVELOPED AREA (IN ²)	WR ^{2**} (LB-IN ²)	
				MINIMUM BORE	MAXIMUM BORE	PILOT BORE				
24	3-1/8	3-1/4	4-5/8	1-1/2	2	1-3/8	57	384	1,990	
26	3-3/8	3-5/8	5	1-3/4	2-1/4	1-1/2	72	451	3,115	
28	3-3/4	4	5-3/4	1-3/4	2-1/2	1-3/4	79	523	3,967	
30	4	4-1/4	6	1-3/4	2-3/4	1-3/4	109	601	6,480	
32	4-1/4	4-1/2	6	2	3	2	150	683	8,847	
34	4-1/4	4-1/2	6-1/2	2	3	2	180	772	11,985	
36	4-3/4	5-1/4	8-1/4	2-3/4	3-1/2	2-1/2	210	864	15,676	
38	5-1/4	5-1/2	8-1/4	2-3/4	3-1/2	2-1/2	240	964	19,961	
40	5-1/4	5-1/2	9	3	3-3/4	3	260	1,068	23,961	
42	5-1/2	6	10-1/2	3	4	3	325	1,177	33,022	
44	5-1/2	6-1/4	10-1/2	3	4	3	370	1,291	41,260	
46	5-1/2	6-1/4	10-1/2	3	4	3	410	1,412	49,975	



// Why Buy MY-T Series Propellers?

Many builders rely on the continued quality and performance of the Hytorq Series of propellers. A significant amount of propellers built in the Michigan Wheel's Grand Rapids foundry are sold to OEMs or as original equipment replacements. By replacing a propeller with a new Michigan Wheel factory equivalent, boaters can guarantee continued performance from their vessel.

SAILBOAT PROPELLERS

Specifications

SAILER 2-BLADE	
Blades	2
E.A.R.	0.31
Diameter Range	10" - 20"

SAILER 3-BLADE	
Blades	3
E.A.R.	0.46
Diameter Range	10" - 20"

"M" SERIES 2-BLADE SAILER	
Blades	2
E.A.R.	0.36
Diameter Range	10" - 18"

"M" SERIES 3-BLADE SAILER	
Blades	3
E.A.R.	0.44
Diameter Range	10" - 18"

"M" SERIES MP3	
Blades	3
E.A.R.	0.53
Diameter Range	9" - 20"

Who Should Buy Michigan "Sailboat" Series Propellers?

Don't let the lack of wind get you down; with Michigan Wheel Sailer series propellers you will always stany underway. Michigan Wheel Sailer propellers are available in 2- and 3-blade configurations, with skewed and non-skewed blades. Sailer series propellers are built with just th eright amount of blade area to optimize efficiency when motoring or sailing.

The MP3 propeller is available with additional blade area for larger, high-powered engines. Whether you are chasing the wind, or riding it, Michigan Wheel Sailer propellers will ensure you are getting the best speed out of your sailboat.



Recreational Applications

Unsure if this is the right propeller for you? Contact your local Michigan Wheel Distributor, or the Michigan Wheel team to review your application.

Excellence in Propulsion

SAILER 2 & 3 BLADE SPECIFICATIONS

DIAMETER		HUB DIMENSIONS (INCHES)			STANDARD TAPER BORE (INCHES)		
INCHES	MM	AFT END	FORWARD END	LENGTH	MINIMUM BORE	MAXIMUM BORE	PILOT BORE
10	254	1-7/16	1-5/8	2-1/4	3/4	7/8	3/4
11	280	1-7/16	1-5/8	2-1/4	3/4	7/8	3/4
12	305	1-9/16	1-3/4	2-3/8	7/8	1-1/8	7/8
13	330	1-9/16	1-3/4	2-3/4	1	1-1/8	1
14	356	1-3/4	2	2-3/4	1	1-1/8	1
15	381	1-3/4	2	2-3/4	1	1-1/8	1
16	406	1-15/16	2-3/16	3-1/4	1-1/8	1-1/4	1-1/8
17	432	2	2-5/16	3-1/4	1-1/8	1-3/8	1-1/8
18	457	2	2-5/16	3-1/4	1-1/8	1-3/8	1-1/8
19	483	2-1/8	2-7/16	3-3/4	1-1/4	1-3/8	1-1/4
20	508	2-1/8	2-7/16	3-3/4	1-1/4	1-3/8	1-1/4

"M" SERIES 2-BLADE & 3-BLADE SAILER SPECIFICATIONS

DIAMETER		HUB DIMENSIONS (INCHES)			STANDARD TAPER BORE (INCHES)		
INCHES	MM	AFT END	FORWARD END	LENGTH	MINIMUM BORE	MAXIMUM BORE	PILOT BORE
10	254	1-7/16	1-5/8	2-1/4	3/4	7/8	3/4
11	279	1-7/16	1-5/8	2-1/4	3/4	7/8	3/4
12	305	1-9/16	1-3/4	2-3/8	7/8	1-1/8	7/8
13	330	1-9/16	1-3/4	2-3/4	1	1-1/8	1
14	356	1-3/4	2	2-3/4	1	1-1/8	1
15	381	1-3/4	2	2-3/4	1	1-1/8	1
16	406	1-15/16	2-3/16	3-1/4	1-1/8	1-1/4	1-1/8
17	432	2	2-5/16	3-1/4	1-1/8	1-3/8	1-1/8
18	457	2	2-5/16	3-1/4	1-1/8	1-3/8	1-1/8

MP 3 SPECIFICATIONS - 0.53 E.A.R.

DIAMETER		HUB DIMENSIONS (INCHES)			STANDARD TAPER BORE (INCHES)			MAXIMUM BLADE WIDTH (INCHES)	EXPANDED AREA PER BLADE (SQ. IN)	APPROX. NET WEIGHT (LBS.)	*WR ² (LBS.-IN ²)
INCHES	MM	AFT END	FORWARD END	LENGTH	MINIMUM BORE	MAXIMUM BORE	PILOT BORE				
9	229	1-5/16	1-7/16	2-1/8	3/4	3/4	3/4	3-7/8	11.0	2.2	6
10	254	1-7/16	1-5/8	2-1/8	3/4	7/8	3/4	4-5/16	13.6	2.9	12
11	279	1-7/16	1-5/8	2-1/8	3/4	7/8	3/4	4-3/4	16.5	3.7	18
12	305	1-9/16	1-3/4	2-5/8	7/8	1-1/8	7/8	5-3/16	19.6	4.6	29
13	330	1-9/16	1-3/4	2-3/4	1	1-1/8	1	5-9/16	23.0	5.5	43
14	356	1-3/4	2	3	1	1-1/8	1	6	26.7	7.5	62
15	381	1-3/4	2	3	1	1-1/8	1	6-7/16	30.6	8.6	87
16	406	1-15/16	2-3/16	3-3/8	1-1/8	1-1/4	1-1/8	6-7/8	34.9	10.8	118
17	432	2	2-5/16	3-3/8	1-1/8	1-3/8	1-1/8	7-5/16	39.3	12.8	161
18	457	2	2-5/16	3-3/8	1-1/8	1-3/8	1-1/8	7-3/4	44.1	14.6	215
19	483	2-1/8	2-7/16	3-3/4	1-1/4	1-3/8	1-1/4	8-3/16	49.1	17.6	299
20	508	2-1/8	2-7/16	3-3/4	1-1/4	1-3/8	1-1/4	8-5/8	54.5	19.8	382



// Which Sailer propeller is right for you?

Michigan Wheel knows that sailors demand the most out of their vessels. Incremental performance gains when under sail and motor are more significant in a sailing vessel. That is why Michigan Wheel offers a wide variety of options to choose from through it's sailer line of propellers. This gives sailors the ability to work with Michigan's team to find the best propeller for their application, because we know every knot counts.

“M” SERIES

Specifications



DJ-355	
Blades	3
E.A.R.	0.56
Diameter Range	9” - 40”

DQ-469	
Blades	4
E.A.R.	0.70
Diameter Range	17” - 44”

DQ-486	
Blades	4
E.A.R.	0.86
Diameter Range	17” - 44”

M-506	
Blades	5
E.A.R.	1.06
Diameter Range	22” - 46”

Who Should Buy “M” Series Propellers?

Michigan Wheel M-Series propellers are globally sourced to offer a competitively priced product that still meets Michigan Wheel’s strict quality standards. M-Series propellers are built from materials that meet ABS type 2 Manganese Bronze and ABS type 4 NiBrAl specifications.

These propellers meet the performance requirements for a number of different pleasure and commercial applications.

DJ355 and DQ469 propellers are 3 and 4 blade propellers built for a wide range of planing boat applications. DQ486 and M-506 are 4 and 5 blade propellers that utilize greater blade area and skew to handle higher power, diameter constrained applications. M-series propellers are available in range of sizes and special sizes are available by request.



Recreational Applications

Unsure if this is the right propeller for you? Contact your local Michigan Wheel Distributor, or the Michigan Wheel team to review your application.

Excellence in Propulsion

DJ355 & DQ469 SPECIFICATIONS								DJ355 - 0.55 E.A.R.				DQ469 - 0.69 E.A.R.			
DIAMETER		HUB DIMENSIONS (INCHES)			STANDARD TAPER BORE (INCHES)			MAXIMUM BLADE WIDTH (INCHES)	EXPANDED AREA PER BLADE (SQ.IN)	APPROX. NET WEIGHT (LBS.)	*WR ² (LBS.-IN ²)	MAXIMUM BLADE WIDTH (INCHES)	EXPANDED AREA PER BLADE (SQ.IN)	APPROX. NET WEIGHT (LBS.)	*WR ² (LBS.-IN ²)
INCHES	MM	AFT END	FORWARD END	LENGTH	MINIMUM BORE	MAXIMUM BORE	PILOT BORE								
9	229	1-3/8	1-1/2	2-1/8	3/4	7/8	3/4	4-1/16	11.7	2.5	7	-	-	-	-
10	254	1-1/2	1-5/8	2-1/4	3/4	1	3/4	4-1/2	14.4	3	12	-	-	-	-
11	279	1-1/2	1-5/8	2-1/4	3/4	1	3/4	4-15/16	17.4	4	19	-	-	-	-
12	305	1-5/8	1-3/4	2-3/8	7/8	1-1/8	7/8	5-3/8	20.7	5	31	-	-	-	-
13	330	1-5/8	1-13/16	2-3/4	1	1-1/8	1	5-7/8	24.3	6	45	-	-	-	-
14	356	1-7/8	2	2-3/4	1	1-1/4	1	6-5/16	28.2	8	65	-	-	-	-
15	381	1-7/8	2	2-3/4	1	1-1/4	1	6-3/4	32.4	9	91	-	-	-	-
16	406	2-1/8	2-3/8	3-1/4	1-1/8	1-3/8	1-1/8	7-1/4	36.9	11	127	-	-	-	-
17	432	2-3/8	2-5/8	3-3/4	1-1/4	1-1/2	1-1/4	7-5/8	41.6	14	173	7-5/16	39.1	17	226
18	457	2-3/8	2-5/8	3-3/4	1-1/4	1-1/2	1-1/4	8-1/8	46.7	16	227	7-3/4	43.9	20	300
19	483	2-3/8	2-5/8	3-3/4	1-1/4	1-1/2	1-1/4	8-1/2	52.0	19	314	8-3/16	48.9	22	394
20	508	2-3/8	2-5/8	3-3/4	1-1/4	1-1/2	1-1/4	9	57.6	21	403	8-5/8	54.2	25	505
21	533	2-3/4	3	4-1/8	1-3/8	1-3/4	1-3/8	9-7/16	63.5	26	514	9	59.7	30	643
22	559	2-3/4	3	4-1/8	1-3/8	1-3/4	1-3/8	9-7/8	69.7	29	647	9-7/16	65.5	34	811
23	584	3	3-1/4	4-1/2	1-1/2	2	1-1/2	10-3/8	76.2	34	808	9-7/8	71.6	40	1,010
24	610	3	3-1/4	4-1/2	1-1/2	2	1-1/2	10-5/8	82.9	37	1,004	10-5/16	78.0	45	1,250
26	660	3-3/8	3-3/4	4-7/8	1-3/4	2-1/4	1-3/4	11-3/4	97.3	48	1,480	11-3/16	91.5	57	1,850
28	711	3-3/4	4-1/8	5-3/4	2	2-1/2	2	12-5/8	112.9	62	2,150	12	106.2	73	2,680
30	762	4-1/4	4-5/8	6	2	3	2	13-1/2	129.6	79	3,020	12-7/8	121.9	92	3,770
32	813	4-1/4	4-5/8	6	2	3	2	14-3/8	147.4	90	4,140	13-3/4	138.7	107	5,180
34	864	4-1/4	4-5/8	6-1/2	2-1/4	3	2-1/4	15-5/16	166.5	105	5,610	14-5/8	156.6	125	7,020
36	914	4-5/8	5-1/8	8	2-3/4	3-1/2	2-3/4	16-3/16	186.6	130	7,420	15-7/16	175.5	153	9,260
38	965	4-5/8	5-1/8	8	2-3/4	3-1/2	2-3/4	17-1/16	207.9	147	9,670	16-5/16	195.6	174	12,080
40	1,016	5	5-1/2	9	3	3-3/4	3	18	230.4	183	13,150	17-3/16	216.7	215	16,440
42	1,067	5-3/8	6	10-7/16	3	4	3	-	-	-	-	18	239.0	263	21,070
44	1,118	5-7/16	6-3/16	11	3	4	3	-	-	-	-	18-7/8	262.3	301	26,460

DQ486 & M-506 SPECIFICATIONS								DQ486 - 0.86 E.A.R.				M-506 - 1.06 E.A.R.			
DIAMETER		HUB DIMENSIONS (INCHES)			STANDARD TAPER BORE (INCHES)			MAXIMUM BLADE WIDTH (INCHES)	EXPANDED AREA PER BLADE (SQ.IN)	APPROX. NET WEIGHT (LBS.)	*WR ² (LBS.-IN ²)	MAXIMUM BLADE WIDTH (INCHES)	EXPANDED AREA PER BLADE (SQ.IN)	APPROX. NET WEIGHT (LBS.)	*WR ² (LBS.-IN ²)
INCHES	MM	AFT END	FORWARD END	LENGTH	MINIMUM BORE	MAXIMUM BORE	PILOT BORE								
17	432	2-3/8	2-5/8	3-3/4	1-1/4	1-1/2	1-1/4	8-1/2	45.4	20	282	-	-	-	-
18	457	2-3/8	2-5/8	3-3/4	1-1/4	1-1/2	1-1/4	9	50.9	23	374	-	-	-	-
19	483	2-3/8	2-5/8	3-3/4	1-1/4	1-1/2	1-1/4	9-1/2	56.7	26	491	-	-	-	-
20	508	2-3/8	2-5/8	3-3/4	1-1/4	1-1/2	1-1/4	10	62.8	30	629	-	-	-	-
21	533	2-3/4	3	4-1/8	1-3/8	1-3/4	1-3/8	10-1/2	69.3	36	799	-	-	-	-
22**	559	2-3/4	3	4-1/8	1-3/8	1-3/4	1-3/8	11	76.0	40	1,010	11-1/4	76.8	48	1,270
23	584	3	3-1/4	Full Taper	1-1/2	2	1-1/2	11-1/2	83.1	47	1,260	11-3/4	83.9	55	1,585
24	610	3	3-1/4	Full Taper	1-1/2	2	1-1/2	12	90.5	52	1,560	12-1/4	91.4	62	1,960
26	660	3-3/8	3-3/4	Full Taper	1-3/4	2-1/4	1-3/4	13	106.2	68	2,310	13-1/4	107.2	80	2,910
28	711	3-3/4	4-1/8	Full Taper	2	2-1/2	2	14	123.2	85	3,340	14-1/4	124.4	101	4,200
30	762	4-1/4	4-5/8	Full Taper	2	3	2	15	141.4	106	4,680	15-5/16	142.8	125	5,890
32	813	4-1/4	4-5/8	Full Taper	2	3	2	16	160.9	124	6,430	16-5/16	162.5	146	8,105
34	864	4-1/4	4-5/8	Full Taper	2-1/4	3	2-1/4	17	181.6	146	8,740	17-5/16	183.4	174	10,980
36	914	4-5/8	5-1/8	Full Taper	2-3/4	3-1/2	2-3/4	18	203.6	178	11,520	18-3/8	205.6	210	14,555
38	965	4-5/8	5-1/8	Full Taper	2-3/4	3-1/2	2-3/4	19	226.8	204	15,020	19-3/8	229.1	242	18,920
40	1,016	5	5-1/2	Full Taper	3	3-3/4	3	20	251.3	250	20,400	20-3/8	253.8	283	24,380
42	1,067	5-3/8	6	Full Taper	3	4	3	21	277.1	291	26,080	21-7/16	279.8	330	31,120
44	1,118	5-7/16	6-3/16	Full Taper	3	4	3	22	304.1	330	32,740	22-7/16	307.1	374	38,980
46	1,168	5-5/8	6-1/4	Full Taper	3	4	3	-	-	-	-	23-7/16	335.7	421	48,480

** Hub Length for the M-506 is full taper.

*WR2 = ±10% in Air (inch squared lbs.)

“CX” SERIES

**THE CX SERIES OF PROPELLERS
BY MICHIGAN WHEEL
REPRESENT THE STATE-OF-THE-
ART IN PROPELLER DESIGN,
CONTROL, AND PERFORMANCE.
EVERY YACHT OWNER WITH A CX
SERIES PROPELLER CAN REST
EASY KNOWING THEY HAVE THE
BEST POSSIBLE PROPELLER
UNDER THEIR BOAT.**

Design

Every CX propeller is designed using state of the art hydrodynamic software, including proprietary code developed by leading propulsion experts as well as cutting edge CFD (computational fluid dynamics). Some propeller manufacturers specify diameter, pitch, and blade area and consider it a custom design, but not Michigan Wheel. Our propulsion experts modify every aspect of the design, including: section shape, camber, thickness, pitch, chord length, rake, and skew for a truly custom design specific to your vessel.

Control

All CX propellers are fully NC machined for optimum accuracy. The use of 5 axis NC machine centers ensures that all hub and blade surfaces match the design geometry. Expert finishers then polish the propeller, leaving a smooth finish to minimize drag. All CX Series propellers are manufactured to close tolerance in accordance with the ISO 484/2 standard.

Performance

The combination of state-of-the-art design and highly accurate manufacturing yields optimum performance for your boat. Take advantage of the increased speed across all engine load, or run at the same speeds as before at lower engine load while burning less fuel. Under heavy use, the fuel savings can pay for the propellers in less than a season. Noise and vibration are also reduced, leading to a quieter and more comfortable ride. Feel confident that you have selected the best custom propeller on the market.

Recreational Applications

*Unsure if this is the right propeller for you? Contact your local Michigan Wheel Distributor,
or the Michigan Wheel team to review your application.*

Excellence in Propulsion



// DESIGN CONSIDERATIONS

While working with builders, the Michigan Wheel design team utilizes a number of tools and programs to optimize propeller design.

Hull (Top Right) and engine (Bottom Left) characteristics are plotted against data provided by the builder/boat designer and the engine companies.

Consideration is given to the stresses on the propeller, in design. (Bottom Right)

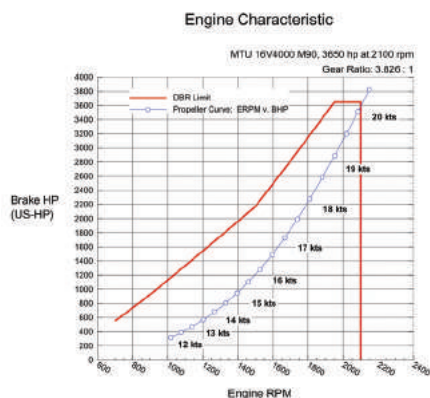
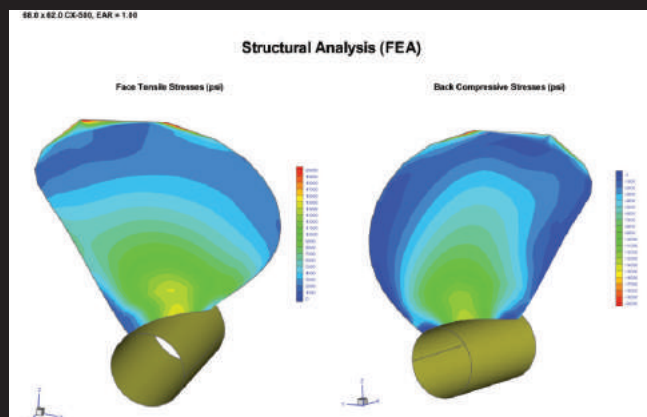
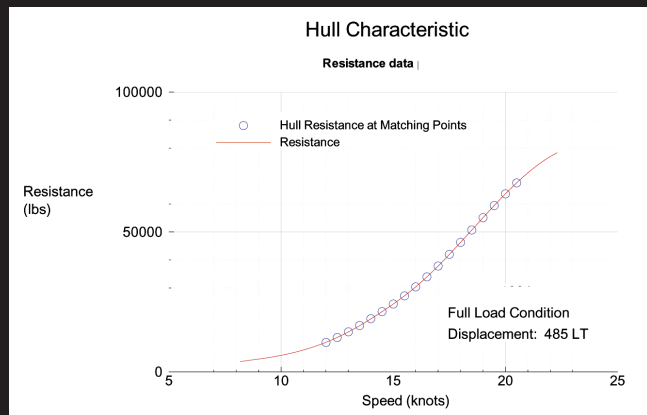



MARLIN SERIES

**“MARLIN SERIES PROPELLERS
CONSISTENTLY OUT-PERFORM
ALL OTHER SPORTFISH
PROPELLERS ON THE MARKET IN
SPEED AND FUEL EFFICIENCY. “**

Who Should Buy Marlin Propellers?

Our Marlin is a subset of custom designs built for truly high speed vessels. Sportfish and Sportcruiser owners who want the best available propeller choose Marlins. Starting from a suite of high tech 4, 5, and 6 blade “parent” designs, each propeller in the Marlin Series is custom designed by Michigan Wheel engineers to work perfectly with your exact vessel.

The “parent” designs on which the Marlin Series is based were developed through a major research effort specifically aimed at optimizing high speed sportfish and sportcruiser propellers. Research involved high performance computer modeling and intensive scale model testing with the goal of managing cavitation and squeezing every last drop of performance from your engine.

Marlin Series propellers consistently out-perform all other sportfish propellers on the market in speed and fuel efficiency. High tech design offers superior top speed, fuel efficiency, and smoothness. By managing cavitation the user can often benefit from reduced maintenance costs and a longer propeller life. A custom designed propeller that is specifically for the boat provides optimal performance when cruising or competing.

Recreational Applications

Unsure if this is the right propeller for you? Contact your local Michigan Wheel Distributor, or the Michigan Wheel team to review your application.

Excellence in Propulsion





Commercial Propellers



NAKASHIMA
Controllable Pitch



NAKASHIMA
Fixed Pitch

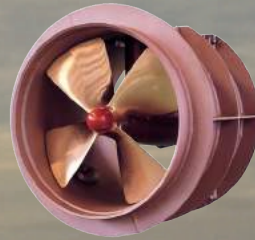

NAKASHIMA
TFN Thruster



NAKASHIMA
TCT Thruster



DQ Special

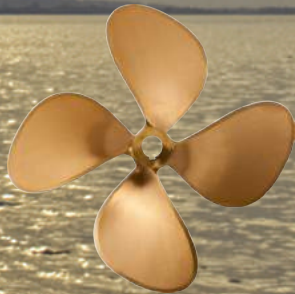

Dura-Quad



Kaplan

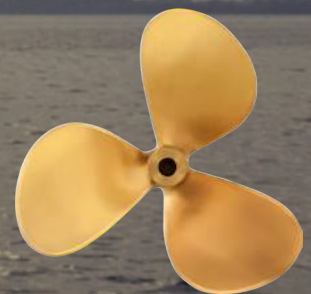

MP-3



Machine Pitch



Maxima

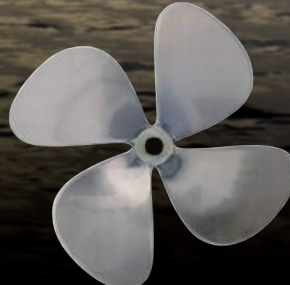

Pac-Master



Trawler



Work Horse



Work Horse 5



Weedless

WORK HORSE & MACHINE PITCH

Specifications

MACHINE PITCH	
Blades	3
Diameter 9" - 60"	E.A.R. 0.51
Diameter 62" - 96"	E.A.R. 0.47

WORK HORSE	
Blades	4
Diameter 18" - 60"	E.A.R. 0.71
Diameter 62" - 96"	E.A.R. 0.62

WORK HORSE 5	
Blades	5
E.A.R.	0.89

Who Should Buy "Work Horse" Series Propellers?

The Michigan Wheel Work Horse and Machine Pitch propellers are the best known commercial boat propellers in the world. Available in 3, 4, and 5 blade models to cover a wide range of commercial vessels. Non-standard blade areas available by request.

The blade design of Work Horse and Machine Pitch Propellers offers durability as well as performance for workboats that need to maximize bollard thrust when pushing and pulling. High quality materials make repairs by your local prop shop easier and help get your vessel back on the water faster. Commercial mariners trust Work Horse and Machine Pitch propellers to get the job done every day.



Commercial Applications

Unsure if this is the right propeller for you? Contact your local Michigan Wheel Distributor, or the Michigan Wheel team to review your application.

Excellence in Propulsion

MACHINE PITCH & WORK HORSE SPECIFICATIONS										MACHINE PITCH		WORK HORSE		WORK HORSE 5	
DIAMETER		HUB DIMENSIONS (INCHES)			STANDARD TAPER BORE (INCHES)			MAXIMUM BLADE WIDTH (INCHES)	EXPANDED AREA PER BLADE (SQ.IN)	APPROX. NET WEIGHT (LBS.)	*WR ² (LBS.-IN ²)	APPROX. NET WEIGHT (LBS.)	*WR ² (LBS.-IN ²)	APPROX. NET WEIGHT (LBS.)	*WR ² (LBS.-IN ²)
INCHES	MM	AFT END	FORWARD END	LENGTH	MINIMUM BORE	MAXIMUM BORE	PILOT BORE								
9	229	1-5/16	1-7/16	2-1/8	3/4	3/4	3/4	3-7/8	11.8	2.5	13	-	-	-	-
10	254	1-7/16	1-5/8	2-1/8	3/4	7/8	3/4	4-5/16	14.5	3.5	21	-	-	-	-
11	279	1-7/16	1-5/8	2-1/8	3/4	7/8	3/4	4-5/8	17.6	4	34	-	-	-	-
12	305	1-9/16	1-3/4	2-5/8	7/8	1-1/8	7/8	5-1/16	20.9	5	50	-	-	-	-
13	330	1-9/16	1-3/4	2-3/4	1	1-1/8	1	4-15/16	22.7	6	65	-	-	-	-
14	356	1-3/4	2	3	1	1-1/8	1	5-5/16	26.4	8	90	-	-	-	-
15	381	1-3/4	2	3	1	1-1/8	1	5-5/8	30.3	9	120	-	-	-	-
16	406	1-15/16	2-3/16	3-3/8	1-1/8	1-1/4	1-1/8	6-15/16	34.5	11	160	-	-	-	-
17	432	2	2-5/16	3-3/8	1-1/8	1-3/8	1-1/8	6-7/16	38.9	12	210	-	-	-	-
18	457	2	2-5/16	3-3/8	1-1/8	1-3/8	1-1/8	6-7/8	43.6	14	280	17	370	-	-
19	483	2-1/8	2-7/16	3-3/4	1-1/4	1-3/8	1-1/4	7-1/4	48.6	16	350	20	480	-	-
20	508	2-1/8	2-7/16	3-3/4	1-1/4	1-3/8	1-1/4	7-1/2	53.8	18	470	23	630	-	-
21	533	2-7/16	2-13/16	4-1/8	1-3/8	1-1/2	1-3/8	8	59.4	22	590	28	790	-	-
22	559	2-7/16	2-13/16	4-1/8	1-3/8	1-1/2	1-3/8	8-3/8	65.1	25	760	32	1,020	-	-
23	584	2-13/16	3-3/16	4-1/2	1-1/2	1-3/4	1-1/2	8-7/8	71.2	30	940	38	1,250	-	-
24	610	2-13/16	3-3/16	4-1/2	1-1/2	1-3/4	1-1/2	9-1/8	77.5	33	1,140	41	1,510	-	-
26	660	3-3/16	3-5/8	5-1/4	1-3/4	2	1-3/4	9-7/8	91	44	1,710	54	2,280	-	-
28	711	3-1/2	4	5-1/4	1-3/4	2-1/4	1-3/4	10-5/8	105.5	55	2,490	68	3,320	-	-
30	762	3-13/16	4-3/8	6	2	2-1/2	2	11-3/8	124.7	70	3,460	87	4,590	108	6,100
32	813	4-1/4	4-13/16	6	2	3	2	12-3/16	141.8	97	5,960	121	7,920	150	10,526
34	864	4-7/16	5-1/16	6-3/4	2-1/4	3-1/4	2-1/4	12-7/8	160.1	114	7,810	142	10,380	177	13,795
36	914	4-3/4	5-1/2	7	2-1/2	3-1/2	2-1/2	13-5/8	179.5	136	10,350	170	13,750	211	18,274
38	965	5-1/16	5-13/16	7-1/4	2-1/2	3-3/4	2-1/2	14-7/16	200	159	13,200	198	17,540	246	23,311
40	1,016	5-1/16	5-13/16	7-3/4	2-3/4	3-3/4	2-3/4	15-3/16	221.6	177	16,600	221	22,070	275	29,331
42	1,067	5-1/4	6	8	2-3/4	3-3/4	2-3/4	15-15/16	244.3	211	22,620	265	30,090	329	39,990
44	1,118	5-1/4	6	8	2-3/4	3-3/4	2-3/4	16-3/4	268.1	232	27,820	293	37,010	364	49,186
46	1,168	6	6-3/4	10	3	4	3	17-7/16	293.1	285	34,170	354	45,400	440	60,337
48	1,219	6	6-3/4	10	3	4	3	18-1/4	319.1	309	41,290	386	54,900	480	72,962
50	1,270	6-9/16	7-3/8	10-3/4	3	4-1/2	3	19	346.2	362	49,820	447	66,190	556	87,967
52	1,320	6-9/16	7-3/8	10-3/4	3	4-1/2	3	19-3/4	374.5	390	59,370	485	78,900	603	104,858
54	1,371	6-9/16	7-3/8	10-3/4	3	4-1/2	3	20-1/2	408.8	420	70,320	526	93,510	654	124,275
56	1,422	7-5/8	8-3/8	11-1/2	3-1/4	5	3-1/4	21-1/4	434.3	498	83,470	615	110,830	764	147,293
58	1,473	7-5/8	8-3/8	11-1/2	3-1/4	5	3-1/4	21-7/8	465.9	533	97,700	661	129,810	822	172,517
60	1,524	7-5/8	8-3/8	12	3-1/2	5	3-1/2	22-3/4	498.6	572	113,880	713	151,360	886	201,157
62	1,575	9	10	13-1/4	4	6	4	22-1/2	492.8	737	143,870	902	190,790	-	-
64	1,625	9	10	13-1/4	4	6	4	23-1/8	525.1	781	165,830	961	220,060	-	-
66	1,676	9	10	13-1/4	4	6	4	23-15/16	558.4	828	190,420	1,024	252,850	-	-
68	1,727	10-1/2	11-3/4	14-1/2	5	7	5	24-5/8	592.8	987	221,140	1,199	292,710	-	-
70	1,778	10-1/2	11-3/4	14-1/2	5	7	5	25-3/8	628.1	1,039	251,690	1,269	333,450	-	-
72	1,823	10-1/2	11-3/4	14-1/2	5	7	5	26-1/8	664.5	1,094	285,590	1,342	378,650	-	-
74	1,879	10-1/2	11-3/4	14-1/2	6	7	6	26-7/8	702	1,159	340,800	1,436	452,320	-	-
76	1,930	10-1/2	11-3/4	14-1/2	6	7	6	27-9/16	740.4	1,228	388,680	1,529	516,160	-	-
78	1,981	10-1/2	11-3/4	14-1/2	6	7	6	28-1/4	779.9	1,301	441,530	1,626	586,630	-	-
80	2,032	11-1/8	12-1/2	17	6	7-1/2	6	29	820.4	1,493	503,610	1,844	668,350	-	-
82	2,083	11-1/8	12-1/2	17	6	7-1/2	6	29-3/4	862	1,574	568,320	1,952	754,640	-	-
84	2,134	11-1/8	12-1/2	17	6	7-1/2	6	30-7/16	904.5	1,659	639,650	2,064	849,740	-	-
86	2,184	11-1/8	12-1/2	17	6	7-1/2	6	31-3/16	948.1	1,748	718,600	2,183	955,010	-	-
88	2,235	11-1/8	12-1/2	17	6	7-1/2	6	31-15/16	992.7	1,842	805,280	2,308	1,070,600	-	-
90	2,286	11-7/8	13-1/4	18-1/4	6	8	6	32-5/8	1,038.3	2,048	903,200	2,547	1,199,900	-	-
92	2,337	11-7/8	13-1/4	18-1/4	6	8	6	33-3/8	1,085.0	2,150	1,003,950	2,683	1,338,260	-	-
94	2,388	11-7/8	13-1/4	18-1/4	6	8	6	34-1/16	1,132.7	2,256	1,119,400	2,825	1,488,200	-	-
96	2,438	11-7/8	13-1/4	18-1/4	6	8	6	34-13/16	1,181.4	2,263	1,238,750	2,869	1,648,600	-	-

COMMERCIAL

Specifications

DQ SPECIAL	
Blades	4
E.A.R.	0.76 - 0.91
Diameter Range	32" - 56"

DURA-QUAD	
Blades	4
E.A.R.	0.76
Diameter Range	24" - 36"

PAC-MASTER	
Blades	4
E.A.R.	0.69
Diameter Range	20" - 30"
Material	Stainless Steel

Who Should Buy Commercial Series Propellers?

Michigan Wheel Dyna-Quad (DQ) propellers have often been used for medium to higher speed commercial applications. Over the years we have created three specialized styles of DQ propellers that meet the needs of many of today's commercial applications.

The DQ Special propeller offers greater blade area than our standard DQ propellers, allowing today's high powered commercial applications to better control cavitation and effectively convert power into thrust.

Dura-Quad propellers utilize thicker blades to hold up better to heavy use in shallow water and contact with floating debris.

Pacmaster propellers offer the sleek design of DQ propellers for operators who prefer the toughness of stainless steel.

THREE SPECIALIZED LINES OF DQ PROPELLERS THAT MEET THE NEEDS OF MANY OF TODAY'S COMMERCIAL APPLICATIONS.

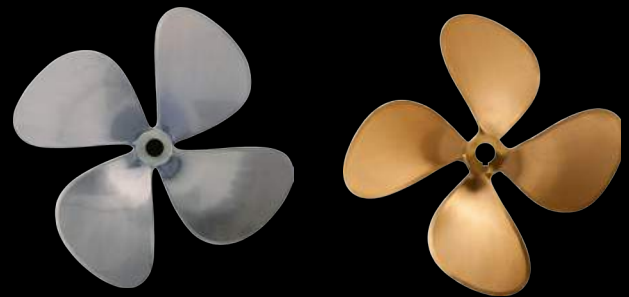

Commercial Applications

Unsure if this is the right propeller for you? Contact your local Michigan Wheel Distributor, or the Michigan Wheel team to review your application.

Excellence in Propulsion

DQ SPECIAL SPECIFICATIONS (0.86 E.A.R.)

DIAMETER		HUB DIMENSIONS (INCHES)			STANDARD TAPER BORE (INCHES)			MAXIMUM BLADE WIDTH (INCHES)	EXPANDED AREA PER BLADE (SQ.IN)	APPROX. NET WEIGHT (LBS.)	*WR ² (LBS.-IN ²)
INCHES	MM	AFT END	FORWARD END	LENGTH	MINIMUM BORE	MAXIMUM BORE	PILOT BORE				
32	813	4-1/4	4-7/8	FULL TAPER	2	3	2	15-11/16	173.1	128	8,250
34	864	4-1/2	5-1/8	FULL TAPER	2-1/4	3	2-1/4	16-11/16	196.3	152	11,150
36	914	4-7/8	5-9/16	FULL TAPER	2-3/4	3-1/2	2-3/4	17-11/16	219.5	184	14,850
38	965	4-7/8	5-9/16	FULL TAPER	2-3/4	3-1/2	2-3/4	18-5/8	245.5	207	19,270
40	1,016	4-7/8	5-11/16	FULL TAPER	3	3-3/4	3	19-5/8	271.6	233	24,710
42	1,067	5-3/8	6	FULL TAPER	3	4	3	20-5/8	298.8	275	31,620
44	1,118	5-3/8	6	FULL TAPER	3	4-1/4	3	21-9/16	328.5	300	39,630
46	1,168	6	6-3/4	FULL TAPER	3	4-1/2	3	22-9/16	359.6	352	46,690
48	1,219	6	6-3/4	FULL TAPER	3	4-1/2	3	23-3/8	387.5	390	61,190
50	1,270	6-3/4	7-1/2	FULL TAPER	3	5	3	24-7/16	420.5	460	75,570
52	1,321	6-3/4	7-1/2	FULL TAPER	3	5	3	25-7/16	456.2	505	91,460
54	1,372	6-3/4	7-1/2	FULL TAPER	3	5	3	26-7/16	493.3	552	109,740
56	1,422	6-3/4	7-1/2	FULL TAPER	3	5	3	27-3/8	531.9	604	131,130

- Notes: 1. Mass moment of inertia properties calculated using minimum standard bore.
 2. Mass moment of inertia properties calculated using bronze.
 3. Some DQ Specials have blade area other than 0.86.

DURA-QUAD SPECIFICATIONS (0.76 E.A.R.)

DIAMETER		HUB DIMENSIONS (INCHES)			STANDARD TAPER BORE (INCHES)				MAXIMUM BLADE WIDTH (INCHES)	EXPANDED AREA PER BLADE (SQ.IN)	APPROX. NET WEIGHT (LBS.)	*WR ² (LBS.-IN ²)
INCHES	MM	AFT END	FORWARD END	LENGTH	MINIMUM BORE	MAXIMUM BORE	PILOT BORE	PILOT S.E. BORE				
24	610	3	3-3/8	6	1-1/2	2	1-1/2	1.172	10-7/16	85.5	52	1,780
26	660	3-3/8	3-7/8	6-3/4	1-3/4	2-1/4	1-3/4	1.375	11-5/16	99.9	67	2,650
28	711	3-3/4	4-1/4	7-1/2	2	2-1/2	2	1.578	12-3/16	115.7	85	3,830
30	762	4-1/4	4-7/8	9	2	3	2	1.531	13-1/16	132.1	113	5,420
32	813	4-1/4	4-7/8	9	2	3	2	1.531	13-15/16	151.1	129	7,420
34	864	4-1/4	4-7/8	9	2	3	2	1.531	14-13/16	171.4	148	9,980
36	914	4-5/8	5-1/4	10-1/2	2-3/4	3-1/2	2-3/4	2.164	15-5/8	191.8	176	13,260

PAC-MASTER SPECIFICATIONS (0.69 E.A.R.)

DIAMETER		ROTATION	HUB DIMENSIONS (INCHES)			STANDARD TAPER BORE (INCHES)			MAXIMUM BLADE WIDTH (INCHES)	EXPANDED AREA PER BLADE (SQ.IN)	APPROX. NET WEIGHT (LBS.)	*WR ² (LBS.-IN ²)
INCHES			AFT END	FORWARD END	LENGTH	MINIMUM BORE	MAXIMUM BORE	PILOT BORE				
20 x 18		R	2-3/4	3	4-1/2	1-1/2	1-3/4	1-1/2	8-1/16	54.2	26	627
20 x 20		R	2-3/4	3	4-1/2	1-1/2	1-3/4	1-1/2	8-1/16	54.2	26	627
22 x 18		R	3	3-1/4	4-7/8	1-3/4	2	1-3/4	8-7/8	65.5	34	1,003
22 x 20		R	3	3-1/4	4-7/8	1-3/4	2	1-3/4	8-7/8	65.5	34	1,003
22 x 22		R	3	3-1/4	4-7/8	1-3/4	2	1-3/4	8-7/8	65.5	34	1,003
24 x 20		R & L	3-3/8	3-3/4	5-3/4	2	2-1/4	2	9-11/16	77.8	46	1,545
24 x 22		R & L	3-3/8	3-3/4	5-3/4	2	2-1/4	2	9-11/16	77.8	46	1,545
24 x 24		R & L	3-3/8	3-3/4	5-3/4	2	2-1/4	2	9-11/16	77.8	46	1,545
26 x 20		R & L	3-7/8	4-1/4	6	2	2-1/2	2	10-1/2	90.9	61	2,302
26 x 22		R & L	3-7/8	4-1/4	6	2	2-1/2	2	10-1/2	90.9	61	2,302
26 x 24		R & L	3-7/8	4-1/4	6	2	2-1/2	2	10-1/2	90.9	61	2,302
26 x 26		R & L	3-7/8	4-1/4	6	2	2-1/2	2	10-1/2	90.9	61	2,302
26 x 30		R & L	3-7/8	4-1/4	6	2	2-1/2	2	10-1/2	90.9	61	2,302
28 x 26		R & L	3-7/8	4-1/4	6	2	2-1/2	2	11-1/4	106.2	72	3,303
28 x 28		R & L	3-7/8	4-1/4	6	2	2-1/2	2	11-1/4	106.2	72	3,303
30 x 20		R	3-7/8	4-1/4	6-1/2	2	2-1/2	2	12-1/16	122.5	85	4,633
30 x 28		R & L	3-7/8	4-1/4	6-1/2	2	2-1/2	2	12-1/16	122.5	85	4,633
30 x 30		R	3-7/8	4-1/4	6-1/2	2	2-1/2	2	12-1/16	122.5	85	4,633

M.W.R. = 0.326

B.T.F. = 0.060

Odd diameter & pitch within 2" of listed are quoted on request.

*WR² = ±10% in Air (inch squared lbs.)

KAPLAN PROPELLERS & NOZZELS

Specifications

KAPLAN	
Blades	3, 4, 5
E.A.R.	Varies
Diameter Range	Many Sizes Available

“SWITCHING TO A DUCTED PROPELLER FROM AN OPEN PROPELLER IS ONE OF THE MOST EFFECTIVE WAYS TO GET MORE THRUST FROM A VESSEL FOR THE SAME INPUT POWER.”

Who Should Buy Kaplan Series Propellers and Nozzles?

Vessels operating at low speeds can benefit from the use of a ducted propeller, which is a Kaplan style propeller operating inside a Kort nozzle. Switching to a ducted propeller from an open propeller is one of the most effective ways to get more thrust from a vessel for the same amount of input power.

Our nozzles are available in Type 19 and Type 37 configurations in addition to custom designs upon request. Type 19 nozzles are best used on boats where forward thrust is of highest importance and backing performance is less crucial. Type 37 nozzles are suggested when both ahead and astern performance is required.

Why Buy Kaplan Series Propellers and Nozzles?

Our high-quality Kaplan propellers are offered in a wide variety of designs and materials. Our high-quality nozzles are manufactured with a unique one-piece inner diameter skin, instead of welded segments which experience erosion at the seams. That, along with heavy duty interior structure and framing, make our nozzles last longer than other nozzles on the market. Simplify your procurement with propellers and nozzles from one source. Advanced, custom designs are available.



 **Commercial Applications**

Excellence in Propulsion

KAPLAN SPECIFICATIONS (0.56 E.A.R.)

DIAMETER		HUB DIMENSIONS (INCHES)			STANDARD TAPER BORE (INCHES)			MAXIMUM BLADE WIDTH (INCHES)	EXPANDED AREA PER BLADE (SQ.IN)	APPROX. NET WEIGHT (LBS.)	*WR ² (LBS.-IN ²)
INCHES	MM	AFT END	FORWARD END	LENGTH	MINIMUM BORE	MAXIMUM BORE	PILOT BORE				
35	889	4-3/4	5-1/2	7-1/2	2-1/2	3-1/2	2-1/2	10-9/16	135	117	6,650
39	991	5-1/16	5-13/16	8	2-3/4	3-3/4	2-3/4	11-3/4	167	154	11,300
43	1,090	5-1/4	6	8-1/4	2-3/4	3-3/4	2-3/4	12-7/8	203	196	18,240
45	1,140	6	6-3/4	10	3	4	3	13-9/16	222	246	23,220
47	1,190	6	6-3/4	10	3	4	3	14-3/16	243	269	28,650
51	1,300	6-9/16	7-3/8	10-3/4	3-1/2	4-1/2	3-1/2	15-3/8	286	341	43,110
53	1,350	6-9/16	7-3/8	10-3/4	3-1/2	4-1/2	3-1/2	15-7/8	309	371	51,920
55	1,400	7-5/8	8-3/8	11-1/2	4	5	4	16-5/8	333	445	63,600
59	1,500	7-5/8	8-3/8	12	4	5	4	17-3/4	383	521	89,230
63	1,600	9	10	13-1/4	4	6	4	19-3/16	436	701	126,330
67	1,700	10-1/2	11-3/4	14-1/2	5	7	5	20-5/8	494	907	175,980
71	1,800	10-1/2	11-3/4	14-1/2	5	7	5	21-11/16	554	1,011	231,530
75	1,905	10-1/2	11-3/4	14-1/2	5	7	5	22-3/4	618	1,128	300,500
79	2,006	11-1/8	12-1/2	17	6	7-1/2	6	24	687	1,350	391,360
83	2,108	11-1/8	12-1/2	17	6	7-1/2	6	25-1/16	758	1,493	495,870
87	2,209	11-1/8	12-1/2	17	6	7-1/2	6	26-1/8	832	1,650	621,740
91	2,311	11-7/8	13-1/4	18-1/4	6-1/2	8	6-1/2	27-7/16	911	1,915	780,850
95	2,413	11-7/8	13-1/4	18-1/4	6-1/2	8	6-1/2	28-1/2	993	2,104	961,860

* WR² = ±10% in Air (inch squared lbs.)

Greater area ratios available and quoted upon request.

For use in commercial Kort Nozzle applications, resulting in 25-50% increased thrust compared to an open wheel, on low speed trawlers, draggers, and harbor tugs.

NSMB TYPE 19 NOZZLE SPECIFICATIONS

NSMB TYPE 37 NOZZLE SPECIFICATIONS

PRINCIPLE DIMENSIONS (INCHES)				APPROXIMATE NET WEIGHT (LBS.)	PRINCIPLE DIMENSIONS (INCHES)				APPROXIMATE NET WEIGHT (LBS.)
A	B	C	D		A	B	C	D	
36	18	43.60	38.16	300	36	18	43.80	41.67	300
40	20	48.45	42.40	585	40	20	48.67	46.30	585
44	22	53.30	46.64	870	44	22	53.53	50.93	870
46	23	55.72	48.75	1,000	46	23	55.97	53.24	1,000
48	24	58.14	50.88	1,150	48	24	58.40	55.56	1,150
52	26	62.98	55.12	1,425	52	26	63.27	60.19	1,425
54	27	65.41	57.24	1,600	54	27	65.70	62.51	1,600
56	28	67.83	59.36	1,725	56	28	68.14	64.82	1,725
60	30	72.68	63.60	2,000	60	30	73.00	69.45	2,000
64	32	77.52	67.84	2,450	64	32	77.87	74.08	2,450
68	34	82.36	72.08	2,850	68	34	82.74	78.71	2,850
72	36	87.21	76.32	3,150	72	36	87.60	83.34	3,150
76	38	92.06	80.56	3,650	76	38	92.47	87.97	3,650
80	40	96.90	84.80	4,150	80	40	97.34	92.60	4,150
84	42	101.74	89.04	5,050	84	42	102.20	97.23	5,050
88	44	106.59	93.28	5,800	88	44	107.07	101.86	5,800
92	46	111.44	97.52	6,500	92	46	111.94	106.49	6,500
96	48	116.28	101.76	7,500	96	48	116.80	111.12	7,500
100	50	121.12	106.00	8,500	100	50	121.67	115.75	8,500
104	52	125.97	110.24	9,600	104	52	126.54	120.38	9,600
108	54	130.82	114.48	11,000	108	54	131.40	125.01	11,000
112	56	135.66	118.72	12,250	112	56	136.27	129.64	12,250
116	58	140.50	122.96	13,750	116	58	141.14	134.27	13,750
120	60	145.35	127.20	16,000	120	60	146.00	128.90	16,000
124	62	150.20	131.44	18,000	124	62	150.87	143.38	18,000
128	64	155.04	135.68	20,000	128	64	155.74	148.16	20,000
132	66	159.88	139.92	23,000	132	66	160.60	152.79	23,000



WEEDLESS PROPELLERS

Specifications

WEEDLESS	
Blades	2
Diameter Range	10" - 30"
Bore	Standard Taper & Straight Bore

Who Should Buy Weedless Propellers?

Michigan Wheel Weedless propellers are specialized propellers used on mudboats in shallow weed infested waters. Their unique highly skewed blades allow the propellers to run freely without becoming tangled in floating vegetation. Thick blades and heavy duty edges add durability when striking roots and other submerged debris. When you are navigating a swamp and need a propeller that will not fail and leave you stranded, choose a Michigan Weedless.

Weedless Propellers in Water Treatment Facilities

Weedless propellers have also become a preferred choice in many water treatment and other industrial applications. Frequently Michigan Wheel weedless propellers are used in projects around the world helping treat water in developing countries. Their unique design minimizes the collection of loose material while they are used to pump untreated water through the plants. Many sizes are available with oversized hubs to accommodate straight bores for connection to pump motor shafts.

Contact Michigan Wheel for help sizing and for availability of size and pitch combinations.

Applications

Unsure if this is the right propeller for you? Contact your local Michigan Wheel Distributor, or the Michigan Wheel team to review your application.

Excellence in Propulsion

WEEDLESS A-C SPECIFICATIONS

DIAMETER		AVAILABLE PITCH	HUB DIMENSIONS (INCHES)			MAXIMUM STRAIGHT BORE (INCHES)	MAXIMUM BLADE WIDTH (INCHES)	EXPANDED AREA PER BLADE (SQ.IN)	APPROX. NET WEIGHT (LBS.)	B.T.F.
INCHES	MM		AFT END	FORWARD END	LENGTH					
6	152		1	1-11/32	1-3/8	1/2	2-5/8	6.2	1	.042
7	178	4L	1-1/16	1-1/2	1-1/2	5/8	3-1/8	8.5	1.5	.042
8	203	6L	1-1/8	1-1/2	1-1/2	5/8	3-9/16	10.8	2	.042
9	229	6L, 7L, 8L	1-1/4	1-11/16	1-7/8	3/4	4-1/8	13.7	3	.042
10	254	6L, 10L	1-7/16	1-3/4	2-1/4	3/4	4-11/16	14.7	3.5	.042

WEEDLESS W-C SPECIFICATIONS

DIAMETER		AVAILABLE PITCH	HUB DIMENSIONS (INCHES)			MAXIMUM STRAIGHT BORE (INCHES)	MAXIMUM BLADE WIDTH (INCHES)	EXPANDED AREA PER BLADE (SQ.IN)	APPROX. NET WEIGHT (LBS.)	B.T.F.
INCHES	MM		AFT END	FORWARD END	LENGTH					
6	152	4L, 5L	1	1-11/32	1-3/8	1/2" Straight No Keyway	2-5/8	6.2	1	.042
7	178	4L, 5L, 8L, 10L	1-1/16	1-1/2	1-1/2	1/2" Straight No Keyway	3-1/8	8.5	1.5	.042
8	203	4L, 5L	1-1/8	1-1/2	1-1/2	5/8" Straight No Keyway	3-9/16	10.8	2	.042
9	229	5L, 6L	1-1/4	1-11/16	1-7/8	5/8" or 3/4" Straight & Slot	4-1/8	13.7	3	.042
10	254	5L, 9L	1-7/16	1-3/4	2-1/4	3/4" Taper & Keyway	4-11/16	14.7	3.5	.042

WEEDLESS SPECIFICATIONS

DIAMETER		AVAILABLE PITCH	HUB DIMENSIONS (INCHES)			MAXIMUM STANDARD TAPER BORE (INCHES)	MAXIMUM STRAIGHT BORE (INCHES)	MAXIMUM BLADE WIDTH (INCHES)	EXPANDED AREA PER BLADE (SQ.IN)	APPROX. NET WEIGHT (LBS.)	B.T.F.
INCHES	MM		AFT END	FORWARD END	LENGTH						
10	254	6R, 8, 10, 12	1-7/16	1-5/8	2-1/4	1	1	6-11/16	21	5	.058
11	279	8, 10, 12	1-7/16	1-5/8	2-1/4	1	1	7-7/16	25	6	.058
12	305	10, 12, 14	1-9/16	1-3/4	2-5/8	1-1/8	1-1/4	8	30	7.5	.058
13	330	8, 10, 12, 14	1-9/16	1-3/4	2-5/8	1-1/8	1-1/4	8-13/16	36	9	.058
14	356	8, 10, 12L, 14, 16	1-3/4	2	3	1-1/8	1-1/4	9-7/16	41	12	.058
15	381	8, 10, 12, 13L, 14, 16	1-3/4	2	3	1-1/8	1-1/4	10	47	14	.058
16	406	8-16 Even	1-15/16	2-3/16	3-3/8	1-1/4	1-3/8	10-11/16	55	16	.058



LARGE COMMERCIAL PROPELLERS

Propellers

Fixed Pitch Propellers

- *Michigan Wheel can now offer some of the largest propellers in the world.*
- *Cutting edge fixed pitch propeller design and innovations such as composite propellers and propeller fin boss caps.*
- *Advanced blade machining and expert hand polishing.*
- *Nakashima offers many years of experience building and designing large propellers.*

Controllable Pitch Propellers

- *Two models available to fit a wide range of applications.*
- *XS for applications up to 5,000 HP uses hydraulic push rod for blade movement.*
- *XL for applications of 5,000 HP and more uses a highly efficient hydraulic cylinder pump package one-third the size of similar systems.*
- *Controllable pitch propeller blade replacement.*

Partners in Propulsion

Michigan Wheel is always looking for new ways to provide cutting edge propulsion technologies to its customers. A natural progression of this is to align with other companies that have the same goals of offering high quality propulsion equipment and excellent service.

Nakashima Propeller Co., Ltd. is a world renowned propeller manufacturer and has built a reputation for offering some of the best propulsion equipment on the market. Michigan Wheel has partnered with Nakashima to expand their offering with a variety of marine propulsion products. This includes fixed and controllable pitch propellers, as well as fixed and controllable pitch thrusters.



NAKASHIMA

We Go Beyond



Commercial Applications

BOW THRUSTERS

Thrusters

Fixed Pitch Bow Thrusters

- Model TFN tunnel thrusters utilize fixed pitch propellers to minimize maintenance costs.
- The tunnel assembly is built with a reinforced structure to allow it to be easily mounted in various types of vessels.

Controllable Pitch Bow Thrusters

- Model TCT is a high performance tunnel thruster with controllable blades.
- Design has been optimized by use of tank tests to maximize thrust while minimizing noise and vibration.
- Available with propeller diameters ranging from 700mm (27.55") to 3,150mm (124").
- Bolt on blades can be easily removed for replacement or repair.

Partners in Propulsion

As a general propulsion system manufacturer, Nakashima designs and manufactures a variety of tunnel thrusters. Nakashima side thrusters can be used in a wide range of vessels including freighters, fishing vessels, ferries, roll-on/roll-off vessels, container ships, offshore supply vessels, and patrol craft.

LEGACY SERIES

Specifications

“Y” SERIES

Blades	3 / 4 / 5
E.A.R.	0.66 / 0.835 / 0.935
Application	Pleasure

“HX” SERIES

Blades	4 / 5
E.A.R.	Varies
Application	Pleasure

MAXIMA

Blades	3 / 4
E.A.R.	0.63 / 0.836
Diameter Range	32” - 50”

TRAWLER

Blades	4
E.A.R.	0.44
Diameter Range	36” - 72”

About our Legacy Series

Over the past century, Michigan Wheel has built many propellers for many different applications. Our pattern vault houses almost ten thousand patterns to support all the various designs required by the countless different applications. As boats have changed over the years and new propeller designs have been developed, some of our propeller designs have become less prominent.

Since many of these legacy designs are highly effective for their applications, Michigan Wheel still supports them and can build brand new replacement propellers to offer the same performance as the original equipment. Replacing propellers with designs not specialized for your application can result in haul-outs, pitch changes, new vibrations, and decreased performance.

REPLACING PROPELLERS WITH DESIGNS NOT SPECIALIZED FOR YOUR APPLICATION CAN RESULT IN HAUL-OUTS, PITCH CHANGES, NEW VIBRATIONS, AND DECREASED PERFORMANCE.”



Excellence in Propulsion

Unsure if this is the right propeller for you? Contact your local Michigan Wheel Distributor, or the Michigan Wheel team to review your application.



“ Our pattern vault houses almost **ten thousand patterns** to support all the various designs required by countless different applications.

“Y” Series



The chosen combination of blade area and skew in this series, along with variable pitch and camber, make for a close efficiency match throughout the entire power curve. Years of propeller design experience have allowed our naval architects to optimize the “Y” design to maximize the performance of virtually all planing hulls. Boat builders choose the “Y” series as standard equipment after appreciating the difference in sea trials compared to less sophisticated product.

Recreational Applications 

“HX” Series



The Federal HX series offers high tolerance hand finish propeller manufacture in a variety of design configurations. This series is primarily constant pitch, with expanded area ratios. High horsepower pleasure and commercial applications require specific propellers to achieve maximum thrust, speed, and smoothness. The proven pitch geometry yields exceptional performance without the additional cost associated with custom, CNC machined propellers.

Recreational Applications 

Maxima



The heavy-duty blade thickness distribution makes the Maxima the most durable commercial offering. The blade design is wider than the standard for applications that require maximum thrust, including: moderate-speed crew supply; high horsepower applications, and passenger boats requiring maximum thrust.

Commercial Applications 

Trawler



The Trawler series gives four blade performance without reduced diameter, and is primarily used on shrimp boats, trawlers, and similar vessels that need thrust and smooth running performance.

Commercial Applications 

Propulsion Solutions

While our CX and Marlin propellers are custom designed for a boat's specific engine power, shaft RPM, and top speed, Michigan Wheel has the capability to go one step further. Through advanced computer modeling and simulation, our engineering team can examine a boat's wake and design a propeller specifically for that wake. Due to different hull shapes, shaft and strut configurations, and other differences, each boat design has its own wake characteristics. Wakes also change with speed as well as load and trim conditions.

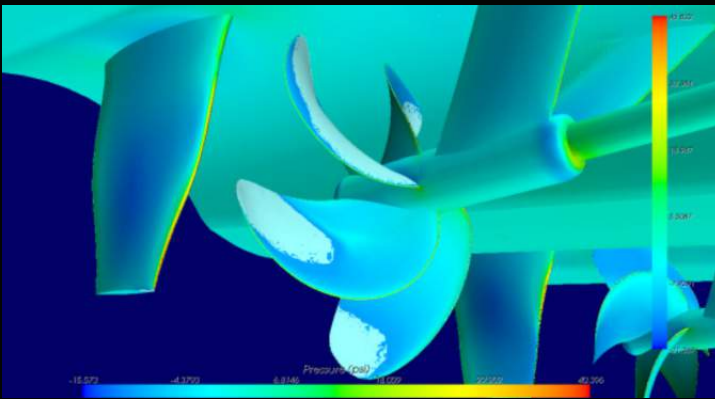

Propellers operate in this region of disturbed water called the wake, and the conditions have a large effect on propeller efficiency and vibration characteristics. A propeller that is designed to take into account these conditions is called a wake-adapted propeller. Wake-adapted propellers offer significant efficiency gains, speed gains, and reductions in vibration.

For a long time, wake-adapted technology was only available through expensive model testing. The advent of high performance computers has allowed highly educated engineers to model the entire boat and appendages and run simulations to analyze the wake and its effect on propellers. Not only is it significantly less costly and less time consuming compared to model testing, but it also allows the propeller designer to study propeller and flow characteristics that would be impossible to measure with model testing.

Michigan Wheel has had great success designing and manufacturing wake-adapted propellers for pleasure craft, work boats, and patrol boats. Benefits compared to off the shelf propellers include reduced fuel costs, higher top speed, and greatly reduced vibrations.

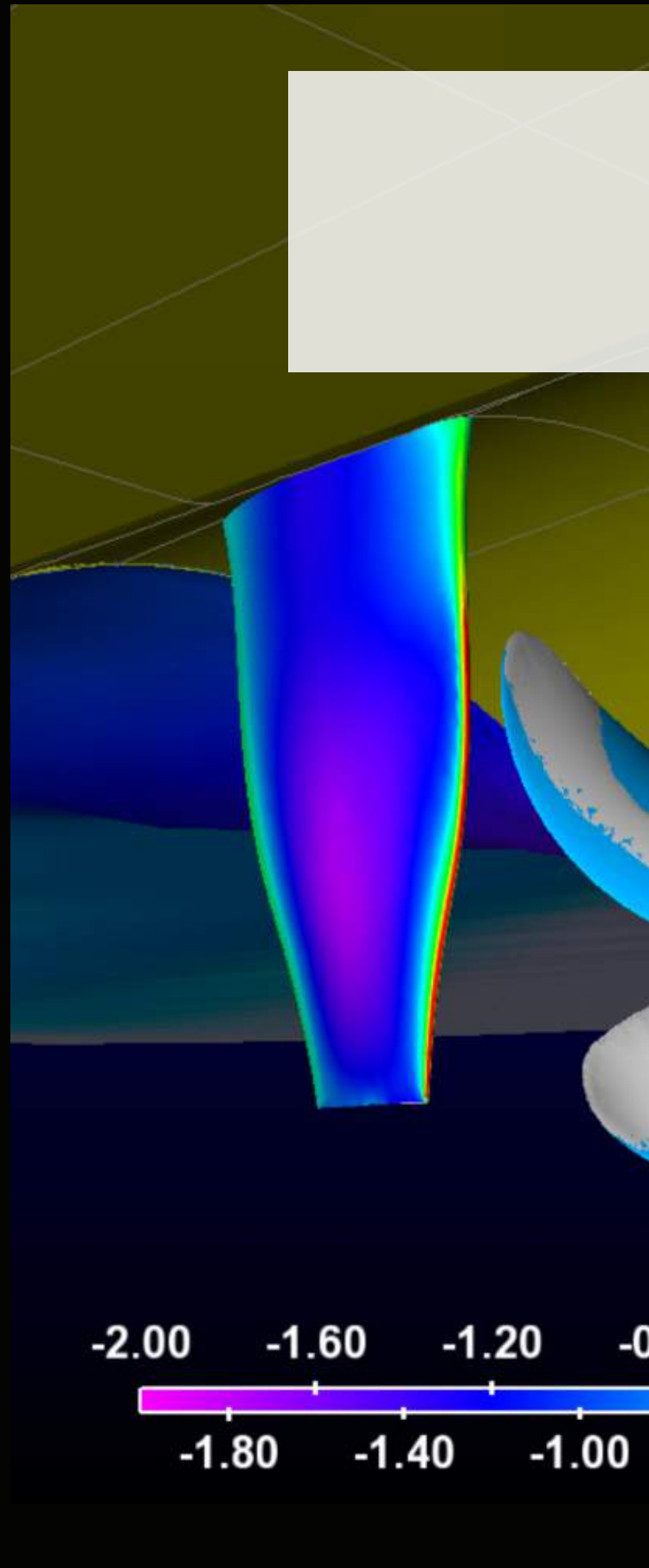

// COMPREHENSIVE PROPULSION SYSTEMS

Significant reduction in fuel costs; significant reduction in vibration amplitude; and an increase in top speed are all benefits to Michigan Wheel's wake-adapted propellers.

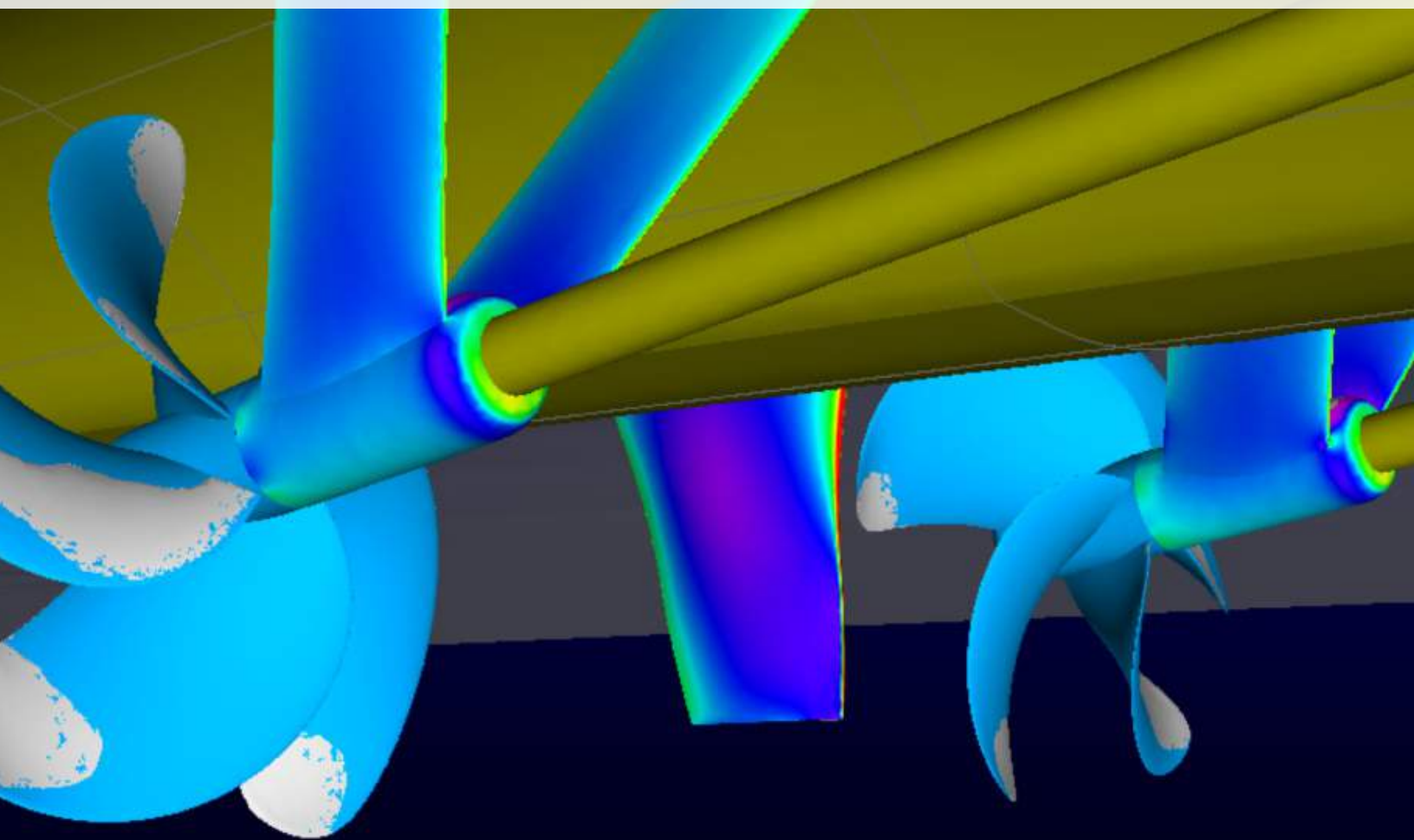

Wave Amplitude (m)



BRASS BEARINGS

Tolerances

Bearing I.D.	O.D. Tolerance (p6)
Inch	Inch
3/4" - 1 1/4"	+0.0010" - +0.0017"
1 3/8"	+0.0013" - +0.0020"
1 1/2" - 1 3/4"	+0.0013" - +0.0020"
1 7/8" - 2 3/8"	+0.0013" - +0.0020"
2 1/2" - 3"	+0.0015" - +0.0023"
3 1/8" - 3 3/4"	+0.0015" - +0.0023"
3 7/8" - 4"	+0.0017" - +0.0027"
4 1/4" - 4 3/8"	+0.0017" - +0.0027"
4 1/2" - 4 7/8"	+0.0017" - +0.0027"
5" - 5 3/8"	+0.0017" - +0.0027"
5 1/2" - 5 3/4"	+0.0017" - +0.0027"
5 7/8"	+0.0020" - +0.0031"
6" - 6 1/4"	+0.0020" - +0.0031"
6 1/2"	+0.0020" - +0.0031"
7"	+0.0020" - +0.0031"
7 1/4" - 10"	+0.0022" - +0.0035"

High-Performance Water Lubricated Aqualube Bearings

Michigan Wheel's Aqualube bearings offer a high quality solution for water lubricated shaft applications. Aqualube bearings are designed with longitudinal grooves that form a hydrodynamic wedge, or water film, between the shaft and the bearing, even during slow speed operation. This water film is capable of absorbing shock, and reducing vibration and noise.

Aqualube bearings are built from chemical and oil resistant nitrile rubber, and are available with brass and non-metallic (Phenolic) shells to fit many applications. Every bearing is inspected to ensure quality. Michigan Wheel stocks a large inventory of common sizes, and special sizes are available upon request.

Why Buy Aqualube Brass Bearings?

Aqualube bearings are consistently built from the highest quality materials. They offer a high resistance to abrasion and long life. When it is time to change your Aqualube bearing, Michigan Wheel offers a large variety of sizes in stock to reduce down time.

Available in Metric & Imperial Sizes.

Phenolic, Brass, and Flanged styles available.

Unsure if this is the right bearing for you? Contact your local Michigan Wheel Distributor, or the Michigan Wheel team to review your application.

Excellence in Propulsion

AQUALUBE BRASS SPECIFICATIONS

DIAMETER		HUB DIMENSIONS (INCHES)			DIAMETER		HUB DIMENSIONS (INCHES)			DIAMETER		HUB DIMENSIONS (INCHES)			
PART No.	MATERIAL	I.D.	O.D.	LENGTH	PART No.	MATERIAL	I.D.	O.D.	LENGTH	PART No.	MATERIAL	I.D.	O.D.	LENGTH	
907501	Brass	3/4	1-1/4	3	927502	Brass	2-3/4	3-1/2	11	AMB040	Brass	40mm	55mm	160mm	-
908751	Brass	7/8	1-1/4	3-1/2	927503	Brass	2-3/4	3-3/4	11	AMB045	Brass	45mm	65mm	180mm	-
908752	Brass	7/8	1-3/8	3-1/2	927701	Brass	2-7/8	3-3/4	11-1/2	AMB050	Brass	50mm	70mm	200mm	-
908753	Brass	7/8	1-1/2	3-1/2	930001	Brass	3	3-3/4	12	AMB055	Brass	55mm	75mm	220mm	-
910001	Brass	1	1-1/4	4	930002	Brass	3	4	12	AMB060	Brass	60mm	80mm	240mm	-
910002	Brass	1	1-3/8	4	931251	Brass	3-1/8	4-1/2	12-1/2	AMB065	Brass	65mm	85mm	260mm	-
910003	Brass	1	1-1/2	4	932501	Brass	3-1/4	4	13	AMB070	Brass	70mm	90mm	280mm	-
910004	Brass	1	1-5/8	4	932502	Brass	3-1/4	4-1/4	13	AMB075	Brass	75mm	95mm	300mm	-
910005	Brass	1	2	4	933751	Brass	3-3/8	4-1/2	13-1/2	AMB080	Brass	80mm	100mm	320mm	-
911251	Brass	1-1/8	1-1/2	4-1/2	935001	Brass	3-1/2	4-1/4	14	AMB085	Brass	85mm	105mm	340mm	-
911252	Brass	1-1/8	1-5/8	4-1/2	935002	Brass	3-1/2	4-1/2	14	AMB090	Brass	90mm	110mm	360mm	-
911253	Brass	1-1/8	1-3/4	4-1/2	936251	Brass	3-5/8	4-1/2	14-1/2	AMB095	Brass	95mm	115mm	380mm	-
911254	Brass	1-1/8	2	4-1/2	937501	Brass	3-3/4	4-1/2	15	AMB100	Brass	100mm	125mm	400mm	-
912501	Brass	1-1/4	1-1/2	5	937502	Brass	3-3/4	5	15	AMB105	Brass	105mm	130mm	420mm	-
912503	Brass	1-1/4	1-3/4	5	937504	Brass	3-3/4	5-1/4	15	AMB110	Brass	110mm	135mm	440mm	-
912505	Brass	1-1/4	2	5	938751	Brass	3-7/8	5-1/4	15-1/2	AMB115	Brass	115mm	145mm	460mm	-
912507	Brass	1-1/4	2-1/8	5	940001	Brass	4	5	16	AMB120	Brass	120mm	155mm	480mm	-
913751	Brass	1-3/8	1-7/8	5-1/2	940002	Brass	4	5-1/4	16	AMB130	Brass	130mm	170mm	520mm	-
913752	Brass	1-3/8	2	5-1/2	941251	Brass	4-1/8	5-1/4	16-1/2	AMB140	Brass	140mm	180mm	560mm	-
913754	Brass	1-3/8	2-1/8	5-1/2	942501	Brass	4-1/4	5-1/2	17						
915001	Brass	1-1/2	2	6	943751	Brass	4-3/8	5-3/4	17-1/2						
915004	Brass	1-1/2	2-3/8	6	945002	Brass	4-1/2	5-1/2	18						
916251	Brass	1-5/8	2-1/8	6-1/2	945004	Brass	4-1/2	5-3/4	18						
916255	Brass	1-5/8	2-5/8	6-1/2	946251	Brass	4-5/8	6-1/8	18-1/2						
917501	Brass	1-3/4	2-3/8	7	947501	Brass	4-3/4	6-1/8	19						
917503	Brass	1-3/4	2-1/2	7	948751	Brass	4-7/8	6-1/8	19-1/2						
917502	Brass	1-3/4	2-5/8	7	950001	Brass	5	6-1/8	20						
918251	Brass	1-7/8	2-5/8	7-1/2	950002	Brass	5	6-1/2	20						
918252	Brass	1-7/8	2-15/16	7-1/2	952501	Brass	5-1/4	6-3/4	21						
920001	Brass	2	2-5/8	8	952502	Brass	5-1/4	7	21						
920002	Brass	2	2-3/4	8	953751	Brass	5-3/8	6-3/4	21-1/2						
920003	Brass	2	3	8	953752	Brass	5-3/8	7	21-1/2						
921252	Brass	2-1/8	2-15/16	8-1/2	955001	Brass	5-1/2	7	22						
921254	Brass	2-1/8	3-1/8	8-1/2	955003	Brass	5-1/2	7-1/4	22						
922501	Brass	2-1/4	2-15/16	9	956251	Brass	5-5/8	7	22-1/2						
922502	Brass	2-1/4	3	9	957501	Brass	5-3/4	7	23						
922503	Brass	2-1/4	3-1/8	9	958751	Brass	5-7/8	7-1/2	24						
922505	Brass	2-1/4	3-3/8	9	960001	Brass	6	7-1/2	24						
923751	Brass	2-3/8	3-3/8	9-1/2	965001	Brass	6-1/2	8-3/8	30						
925002	Brass	2-1/2	3-1/8	10	AMB025	Brass	25mm	40mm	100mm						
925003	Brass	2-1/2	3-1/4	10	AMB028	Brass	28mm	42mm	112mm						
925004	Brass	2-1/2	3-3/8	10	AMB030	Brass	30mm	45mm	120mm						
925005	Brass	2-1/2	3-1/2	10	AMB032	Brass	32mm	45mm	128mm						
926252	Brass	2-5/8	3-3/8	10-1/2	AMB035	Brass	35mm	50mm	140mm						
927501	Brass	2-3/4	3-3/8	11	AMB038	Brass	38mm	55mm	152mm						

DIAMETER		HUB DIMENSIONS (INCHES)				
PART No.	MATERIAL	I.D.	O.D.	LENGTH	FLANGE DIAMETER	FLANGE THICKNESS
	Brass	3-1/2	4-7/8	14	7-3/8	1/2
	Brass	3-3/4	5-1/4	15	7-3/4	1/2
	Brass	4	5-1/2	16	8	1/2
	Brass	4-1/4	5-3/4	17	8-1/4	1/2
	Brass	4-1/2	6	18	8-7/8	1/2
	Brass	4-3/4	6-1/4	19	9-1/8	1/2
	Brass	5	6-3/4	20	9-5/8	9/16
	Brass	5-1/4	6-7/8	21	9-7/8	9/16
	Brass	5-1/2	7-1/4	22	10-1/4	9/16
	Brass	5-3/4	7-1/4	23	10-1/4	9/16
	Brass	6	7-3/4	24	11	9/16
	Brass	6-1/4	8	22-1/2	10-5/8	9/16
	Brass	6-1/2	8-3/8	23-1/2	11	9/16
	Brass	7	9	25-1/2	11-5/8	9/16
	Brass	7-1/4	9-1/4	26-1/2	11-7/8	9/16
	Brass	7-1/2	9-5/8	27-1/2	12-1/4	9-16
	Brass	7-3/4	9-7/8	28-1/2	12-1/2	9/16
	Brass	8	10-1/4	29-1/2	11-1/4	5/8
	Brass	8	10-1/2	29-1/2	13-1/4	5/8
	Brass	8-1/2	10-3/4	31-1/2	13-1/2	5/8
	Brass	9	11-1/4	33-1/2	14-1/4	3/4
	Brass	9-1/4	11-1/2	34-1/2	14-5/8	3/4
	Brass	9-1/4	11-3/4	35-1/2	14-7/8	3/4

FLANGED BEARINGS CURRENTLY AVAILABLE BY SPECIAL REQUEST ONLY.

PHENOLIC BEARINGS

Tolerances

Bearing I.D.	O.D. Tolerance (p6)
Metric	Metric
20 mm - 35 mm	+0.026mm - +0.042mm
38 mm	+0.032mm - +0.051mm
40 mm - 45 mm	+0.032mm - +0.051mm
50 mm - 60 mm	+0.032mm - +0.051mm
65 mm - 75 mm	+0.037mm - +0.059mm
80 mm - 95 mm	+0.037mm - +0.059mm
96 mm - 100 mm	+0.043mm - +0.068mm
105 mm - 110 mm	+0.043mm - +0.068mm
115 mm - 125 mm	+0.043mm - +0.068mm
135 mm	+0.043mm - +0.068mm
140 mm - 150 mm	+0.050mm - +0.079mm
155 mm - 160 mm	+0.050mm - +0.079mm
165 mm - 170 mm	+0.050mm - +0.079mm
175 mm - 180 mm	+0.050mm - +0.079mm
190 mm - 260 mm	+0.056mm - +0.088mm

High-Performance Water Lubricated Aqualube Bearings

Michigan Wheel's Aqualube bearings offer a high quality solution for water lubricated shaft applications. Aqualube bearings are designed with longitudinal

grooves that form a hydrodynamic wedge, or water film, between the shaft and the bearing, even during slow speed operation. This water film is capable of absorbing shock, and reducing vibration and noise.

Aqualube bearings are built from chemical and oil resistant nitrile rubber, and are available with brass and non-metallic (Phenolic) shells to fit many applications. Every bearing is inspected to ensure quality. Michigan Wheel stocks a large inventory of common sizes, and special sizes are available upon request.

Why Buy Aqualube Phenolic Bearings?

All Aqualube bearings are engineered to be compatible with metric or imperial shaft tolerances. 100% of the bearings produced are inspected for quality and must meet Michigan's strict quality standards before they are released to our customers. Phenolic shells are less reactive and can help reduce chances of corrosion in some applications such as aluminum hulls.

Available in Metric & Imperial Sizes.

Phenolic, Brass, and Flanged styles available.

Unsure if this is the right bearing for you? Contact your local Michigan Wheel Distributor, or the Michigan Wheel team to review your application.

Excellence in Propulsion

AQUALUBE PHENOLIC SPECIFICATIONS

DIAMETER		HUB DIMENSIONS (INCHES)			DIAMETER		HUB DIMENSIONS (INCHES)			DIAMETER		HUB DIMENSIONS (INCHES)		
PART No.	MATERIAL	I.D.	O.D.	LENGTH	PART No.	MATERIAL	I.D.	O.D.	LENGTH	PART No.	MATERIAL	I.D.	O.D.	LENGTH
961020	Phenolic	3/4	1-1/4	3	962120	Phenolic	2-1/4	3	9	963340	Phenolic	5	6-1/2	20
961060	Phenolic	7/8	1-1/4	3-1/2	962140	Phenolic	2-1/4	3-1/8	9	963360	Phenolic	5-1/4	6-3/4	21
961070	Phenolic	7/8	1-3/8	3-1/2	962160	Phenolic	2-1/4	3-3/8	9	963370	Phenolic	5-1/4	7	21
961080	Phenolic	7/8	1-1/2	3-1/2	962220	Phenolic	2-3/8	3-3/8	9-1/2	963400	Phenolic	5-3/8	6-3/4	21-1/2
961102	Phenolic	1	1-1/4	4	962320	Phenolic	2-1/2	3-1/8	10	963410	Phenolic	5-3/8	7	21-1/2
961110	Phenolic	1	1-3/8	4	962330	Phenolic	2-1/2	3-1/4	10	963420	Phenolic	5-1/2	7	22
961120	Phenolic	1	1-1/2	4	962340	Phenolic	2-1/2	3-3/8	10	963440	Phenolic	5-1/2	7-1/4	22
961130	Phenolic	1	1-5/8	4	962350	Phenolic	2-1/2	3-1/2	10	963500	Phenolic	5-5/8	7	22-1/2
961150	Phenolic	1	2	4	962420	Phenolic	2-5/8	3-3/8	10-1/2	963620	Phenolic	5-3/4	7	23
961300	Phenolic	1-1/8	1-1/2	4-1/2	962520	Phenolic	2-3/4	3-3/8	11	963660	Phenolic	5-7/8	7-1/2	24
961320	Phenolic	1-1/8	1-5/8	4-1/2	962530	Phenolic	2-3/4	3-1/2	11	963720	Phenolic	6	7-1/2	24
961340	Phenolic	1-1/8	1-3/4	4-1/2	962540	Phenolic	2-3/4	3-3/4	11	AMNM025	Phenolic	25mm	40mm	100mm
961360	Phenolic	1-1/8	2	4-1/2	962580	Phenolic	2-7/8	3-3/4	12	AMNM028	Phenolic	28mm	42mm	112mm
961500	Phenolic	1-1/4	1-1/2	5	962620	Phenolic	3	3-3/4	12	AMNM030	Phenolic	30mm	45mm	120mm
961540	Phenolic	1-1/4	1-3/4	5	962640	Phenolic	3	4	12	AMNM032	Phenolic	32mm	45mm	128mm
961560	Phenolic	1-1/4	2	5	962680	Phenolic	3-1/8	4-1/4	12-1/2	AMNM035	Phenolic	35mm	50mm	140mm
961580	Phenolic	1-1/4	2-1/8	5	962720	Phenolic	3-1/4	4	13	AMNM038	Phenolic	38mm	55mm	152mm
961700	Phenolic	1-3/8	1-7/8	5-1/2	962740	Phenolic	3-1/4	4-1/4	13	AMNM040	Phenolic	40mm	55mm	160mm
961720	Phenolic	1-3/8	2	5-1/2	962780	Phenolic	3-3/8	4-1/2	13-1/2	AMNM045	Phenolic	45mm	65mm	180mm
961740	Phenolic	1-3/8	2-1/8	5-1/2	962820	Phenolic	3-1/2	4-1/4	14	AMNM050	Phenolic	50mm	70mm	200mm
961760	Phenolic	1-3/8	2-3/8	5-1/2	962840	Phenolic	3-1/2	4-1/2	14	AMNM055	Phenolic	55mm	75mm	220mm
961800	Phenolic	1-1/2	2	6	962880	Phenolic	3-5/8	4-1/2	14-1/2	AMNM060	Phenolic	60mm	80mm	240mm
961820	Phenolic	1-1/2	2-3/8	6	962920	Phenolic	3-3/4	4-1/2	15	AMNM065	Phenolic	65mm	85mm	260mm
961860	Phenolic	1-5/8	2-1/8	6-1/2	962940	Phenolic	3-3/4	5	15	AMNM070	Phenolic	70mm	90mm	280mm
961870	Phenolic	1-5/8	2-5/8	6-1/2	962960	Phenolic	3-3/4	5-1/4	15	AMNM075	Phenolic	75mm	95mm	300mm
961900	Phenolic	1-3/4	2-3/8	7	962980	Phenolic	3-7/8	5-1/4	15-1/2	AMNM080	Phenolic	80mm	100mm	320mm
961920	Phenolic	1-3/4	2-1/2	7	963020	Phenolic	4	5	16	AMNM085	Phenolic	85mm	105mm	340mm
961940	Phenolic	1-3/4	2-5/8	7	963040	Phenolic	4	5-1/4	16	AMNM090	Phenolic	90mm	110mm	360mm
961960	Phenolic	1-7/8	2-5/8	7-1/2	963060	Phenolic	4-1/8	5-1/4	16-1/2	AMNM095	Phenolic	95mm	115mm	380mm
961970	Phenolic	1-7/8	2-15/16	7-1/2	963080	Phenolic	4-1/4	5-1/2	17	AMNM100	Phenolic	100mm	125mm	400mm
962000	Phenolic	2	2-5/8	8	963100	Phenolic	4-3/8	5-3/4	17-1/2	AMNM105	Phenolic	105mm	130mm	420mm
962010	Phenolic	2	2-3/4	8	963120	Phenolic	4-1/2	5-1/2	18	AMNM110	Phenolic	110mm	135mm	440mm
962020	Phenolic	2	3	8	963140	Phenolic	4-1/2	5-3/4	18	AMNM115	Phenolic	115mm	145mm	520mm
962060	Phenolic	2-1/8	2-15/16	8-1/2	963180	Phenolic	4-5/8	6-1/8	18-1/2	AMNM120	Phenolic	120mm	155mm	480mm
962070	Phenolic	2-1/8	3-1/8	8-1/2	963200	Phenolic	4-3/4	6-1/8	19	AMNM130	Phenolic	130mm	170mm	520mm
962100	Phenolic	2-1/4	2-15/16	9	963220	Phenolic	4-7/8	6-1/8	19-1/2					



Aqualube bearings are molded from a specially compounded oil and chemical resistant nitrile rubber. The nitrile rubber displays an excellent resistance to wear and abrasion and is also tough and durable. Bonded techniques developed by Michigan Wheel ensure that the strength of the bond to the shell is at least equal to the strength of the rubber itself.

Hale



*Accurate recording of propeller condition. Precise measurements of:
pitch, rake, track, spacing, geometry, and camber.*



Advanced Technology in Electronic 3-D Propeller Analysis

Experienced propeller repair facilities prefer the Hale MRI for performing detailed and accurate propeller measurement. With the MRI's comprehensive reporting capability, the propeller technician can record and document the exact condition of a customer's propeller. The resulting concise and visual summary can assist customers in determining the optimal repair or reconditioning service best suited for their needs.



MRI Features Include:

- Compatibility with Windows 7.
- Durable rotary and linear encoders that provide continuous and highly accurate 3D readings to the computer for analysis and recording.
- Measurements and reporting of Pitch, Rake, Track, Angular Spacing, Section Face Camber, and other geometric features for ANY propeller.
- Ability to compare one propeller to another, such as left hand vs. right hand rotation, or two of the same rotation. This allows for the exact matching of a propeller set.
- Permanent computer record of pre and post repair activities, which can be transferred to another MRI user via e-mail or data storage devices. With this information, any MRI user has the necessary details to provide a subsequent repair or recondition service resulting in a finished propeller closely matching the original. If replacement is necessary, the detailed dimensional information can be supplied to the propeller manufacturer for review and determination of an optimal new propeller.

// COMPANY HISTORY

With over a century of history, Michigan Wheel has become synonymous with reliable, quality propellers. Despite changes in ownership and cycles in the marine industry, Michigan Wheel has remained a dedicated supplier of marine propellers to the recreational and commercial marine industry.





Today, Michigan Wheel offers tens of thousands of variations of propellers, and still retains its leadership position in original equipment and aftermarket propeller supply. The “Michigan” name is recognized and demanded worldwide. Much of the credit goes to the loyal and supportive Michigan Wheel distributor and builder base, and with the dedicated Michigan Wheel employees.

An extensive history with marine propulsion has provided Michigan Wheel with a solid foundation to continue exceeding marine industry demands.

1903

Michigan Wheel is organized by Harry Perkins as a machine shop for the production of a variety of items, including marine propellers.

1934

Hall & Stavert is founded as a two man partnership. It will grow to become the largest propeller manufacturer in Canada.

1949

Michigan Wheel Company purchases Federal Propellers, uniting the primary suppliers of recreational propellers. With a combined volume in production, Michigan Wheel Company is able to incorporate efficient manufacturing processes.

1970-1979

Under new ownership by the Dana Corporation, the Michigan Wheel Company becomes Michigan Wheel Corporation, and buys Coolidge Propeller in Seattle, WA; and Gulf Coast Propeller in Pascagoula, MS.

1980-1989

Computer-controlled milling gains favor, and Michigan Wheel takes advantage as one of the first to implement NC machining. Michigan Wheel’s CAD-CAM abilities are unsurpassed in the ranks of propeller manufacturers.

1997

Michigan Wheel acquires Canadian propeller competitor Hall & Stavert, manufacturer of the HyTorq Propeller series.

2005

Michigan Wheel opens a facility in the UK, Michigan Wheel - Europe, launching a new range of inboard propellers - GOLD Line.

2009

Under new ownership (The Anderson Group), Michigan Wheel Corporation is reorganized as Michigan Wheel Marine.

2010

Michigan Wheel opens a facility in Dubai, United Arab Emirates, Michigan Wheel MEAA.

2010

Michigan Wheel acquires UK bearing manufacturer Shearwater Marine, and introduces Aqualube to the American marketplace.

2013

Michigan Wheel and Nakashima Propeller form a strategic partnership, allowing Michigan Wheel to offer propellers up 13m in diameter, controllable pitch propellers, and thrusters.

// PROPELLER TERMS AND DEFINITIONS

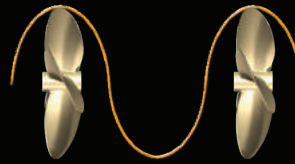

Pitch

The linear distance that a propeller would move in one revolution with no slippage.

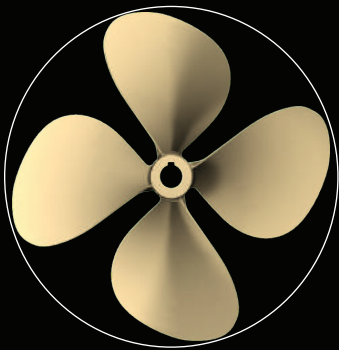

Diameter

The diameter of the imaginary circle scribed by the blade tips as the propeller rotates.

Blade Number

Equal to the number of blades on the propeller. *(4-blade shown.)*

Radius

The distance from the axis of rotation to the blade tip. The radius multiplied by two is equal to the diameter.

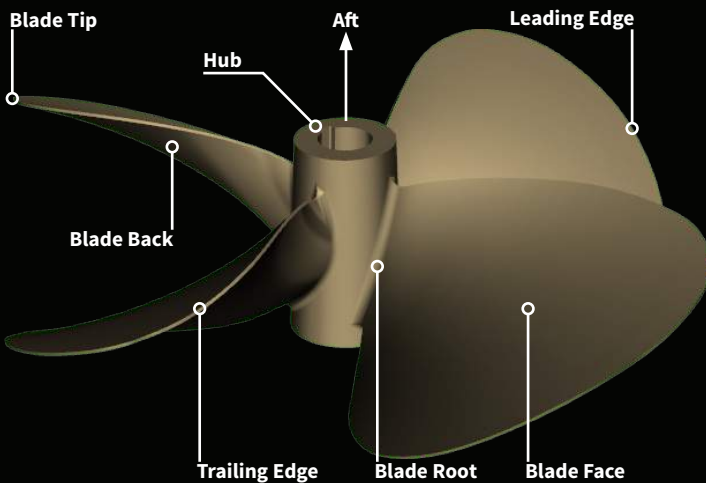

Leading Edge

The edge of the propeller blade adjacent to the forward end of the hub. When viewing the propeller from astern, this edge is furthest away. The leading edge leads into the flow when providing forward thrust.

Trailing Edge

The edge of the propeller adjacent to the forward end of the hub. When viewing the propeller from astern, this edge is closest. The trailing edge retreats from the flow when providing forward thrust.

Blade Tip

Maximum reach of the blade from the center of the hub. Separates the leading and trailing edges.

Blade Root

Fillet area. The region of transition from the blade surfaces and edges to the hub periphery. The area where the blade attaches to the hub.

Blade Back

Suction side. Forward side of the blade (surface facing the bow).

Blade Face

Pressure side; pitch side. Aft side of the blade (surface facing the stern).

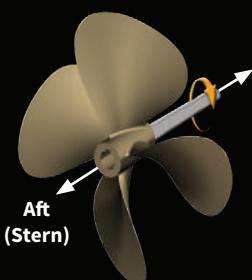

Rotation

When viewed from the stern (facing forward): Right-Hand propellers rotate clockwise to provide forward thrust; Left-Hand propellers rotate counter-clockwise.

Hub

Solid cylinder located at the center of the propeller. Bored to accommodate the engine shaft. Hub shapes include cylindrical, conical, radius, and barreled.

Cup

Small radius of curvature located on the trailing edge of the blade.

// PROPELLER TERMS AND DEFINITIONS

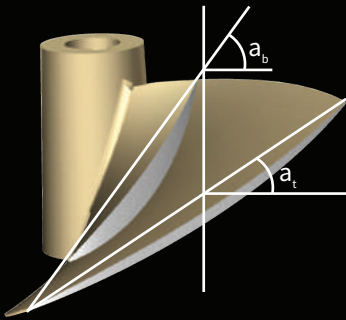

Pitch Reference Line

Reference line used to establish the geometric pitch angle for the section. This line may pass through the leading and trailing edges of the section and may be equivalent to the chord line. *(Image shown.)*

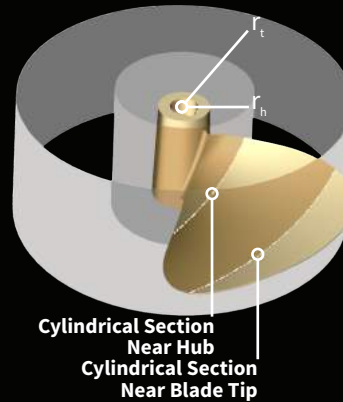

Cylindrical Section

A cross section of a blade cut by a circular cylinder whose centerline is the propeller axis of rotation.

r_t = The radius of a cutting cylinder near the hub. The cylindrical section near the hub is located on the surface of this cylinder.

r_h = The radius of a cutting cylinder near the tip. The cylindrical section near the tip is located on the surface of this cylinder.

Track

The absolute difference of the actual individual blade height distributions to the other blade height distributions. Always a positive value, and represents the spread between individual blade height distributions.

Geometric Pitch Angle

The angle between the pitch reference line and a line perpendicular to the propeller axis of rotation.

Controllable Pitch Propeller

The propeller blades mount separately to the hub, each on an axis of rotation, allowing a change of pitch in the blades and thus the propeller.

Fixed Pitch Propeller

The propeller blades are permanently mounted and do not allow a change in the propeller pitch.

Constant Pitch Propeller

The propeller blades have the same value of pitch from root to tip, and from leading edge to trailing edge.

Variable Pitch Propeller

The propeller blades have sections designed with varying values of local face pitch to pitch.

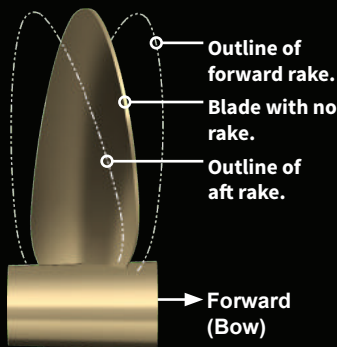

Rake

The fore or aft slant of a blade with respect to a line perpendicular to the propeller axis of rotation.

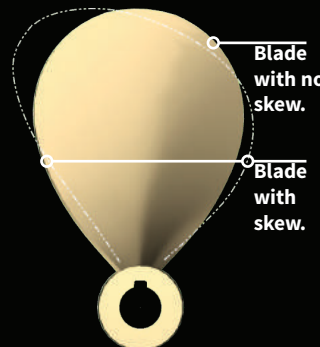

Skew

The transverse sweeping of a blade such that viewing the blades from fore or aft shows an asymmetrical shape.

Aft Rake

Positive rake. Blades slant toward the aft end of the hub.

Forward Rake

Negative rake. Blades slant toward the forward end of the hub.

Aft Skew

Positive skew. Blade sweep in direction opposite of rotation.

Forward Skew

Negative skew. Blade sweep in the same direction as rotation.

APPROVED S.A.E. STANDARD DIMENSIONS FOR SHAFTS 3/4 TO 3 INCHES IN DIAMETER

Table with columns: Nom Shaft Diameter, Diameter Small End, Taper Length, Keyway Width, Keyway Side Depth, Keyway Fillet Radius, Thread, End of Taper to End of Thread, Ext. Beyond Taper, Undercut, Dia. of Pin End, Length of Pin End, Cotter-Pin Hole, Cotter-Pin, Nuts (iv), Keyway Length.

MARINE PROPELLER SHAFT END DIMENSIONS

DIMENSIONS OF SHAFTS FROM 3-1/4 TO 8 INCHES IN DIAMETER

Table with columns: Nom Shaft Diameter, Diameter Small End, Taper Length, Keyway Width, Keyway Side Depth, Keyway Fillet Radius, Thread, End of Taper to End of Thread, Ext. Beyond Taper, Undercut, Dia. of Pin End, Length of Pin End, Cotter-Pin Hole, Cotter-Pin, Nuts, Sleeve Drive (v), Clearance, Keyway Length.

MARINE PROPELLERS HUB BORE DIMENSIONS

Table with columns: Std. Taper, Dia. Small End 'A', Keyway Width 'C', Keyway Side Depth 'D', Max., Min., Nom., Keyway Side Depth 'D', Max., Min., Nom.

- *6" through 8" shaft has 1 inch per foot taper, 1/12" per inch taper. Angle with centerline is 2° 23' 9" (l) Keyway shall be cut parallel to taper. (m) Fillets are recommended for keyways in shafts through 2" in diameter. Fillets are mandatory for shafts above 2" in diameter. (n) Nuts are to be semi-finished stock, American Standard B18.2. (v) The shaft sleeve shown is recommended practice, but the use of a sleeve is optional.

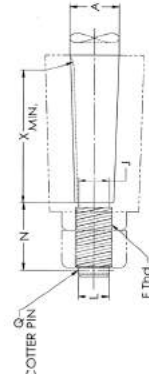
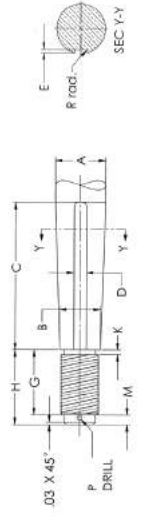

To insure retention of inherent factory accuracy, order your propeller factory-bored whenever possible. When bored in the field, propellers should be bored to the pilot hole, NOT to the hub or blade edges. *6" through 8" shaft has 1 inch per foot taper, 1/12" per inch taper. Angle with centerline is 2° 23' 9". Overseas specifications on request.

INBOARD PROPELLER INSTALLATION PROCESS

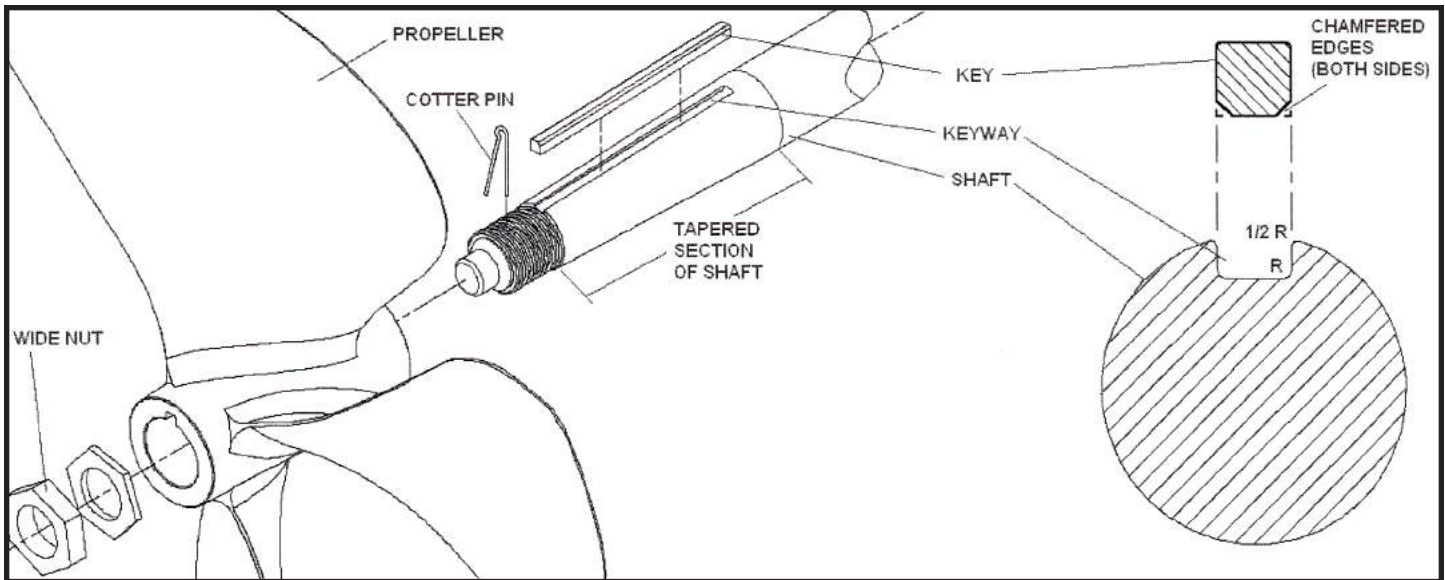

1. Push propeller snugly onto shaft taper WITHOUT key in either keyway (propeller or shaft).
2. Make sure the propeller is snug and there is no side to side movement by gently moving the propeller back and forth.
3. Make a line on the shaft with a non-graphite marker at the forward end of the propeller where it stops up against the shaft taper.
4. Remove propeller.
5. Put key into keyway on shaft taper with radiused or chamfered corners (down) in shaft keyway. (If propeller shaft keyway has radiused corners.)
6. Put propeller back onto shaft taper.
7. Check to see that the propeller moves back to the forward line made in Step 3. If it does, skip to Step 8. If it does not, perform the following:
 - a. Remove propeller from shaft.
 - b. Place a file on a flat surface area or work bench.
 - c. Run opposite end of chamfered key back and forth over file (to remove any burrs) with a downward pressure on key until side being filed is clean.
 - d. Install cleaned key in shaft keyway with chamfered corner side down in the shaft (the cleaned, filed side up in keyway).
 - e. Replace the propeller on the shaft and fit snugly on taper. Check to see if it reaches the line made as in Step 7. If it does not line up, repeat steps 7a through 7e.

Note: A vise can be used to hold key and then filed, but care must be taken not to tighten too much, causing burrs and irregularities on key.
8. When propeller hub moves to the correct position, install propeller nut on shaft and torque to seat the propeller. Install the torque jam nut also, if your shaft is so equipped.
9. Install cotter pin at the end of the shaft.



Inboard Propeller Sizing Form

Name: _____ Address: _____ Project: _____ Date: _____
 Company: _____ City/State/Zip: _____ Email: _____ Phone/Fax: _____

Boat Information

Manufacturer: _____ Model: _____ Pleasure: Commercial:
 New Model Existing Model Alternative Power Configuration

Boat Type - Use: _____ For Fishing, Tug or, Pushboat - Working Speed: _____

Overall Length (LOA): _____ Waterline Length (LWL): _____ Displacement: _____ Pockets: _____
 Beam (B): _____ Draft (T): _____ LCG from Stern: _____
 Deadrise Angle at Stern: _____ Running Trim Angle: _____ Shaft Inclination Angle: _____ Tunnels: _____
 Distance: Shaft Centerline @ Propeller to Bottom: _____ Maximum Desired Propeller Diameter: _____ Desired Number of Blades: _____
 Distance: Shaft Centerline @ Propeller to Waterline: _____ Projected Vessel Speed: _____ Other: _____

Engine Information

Manufacturer: _____ Single: Twin: Triple: Other: Year: _____ Diesel: Gas:
 Engine Rating _____ Shaft: _____ Continuous: _____ Intermittent: _____ Horsepower _____ RPM _____ **Desired Engine RPM:** _____
 Brake: _____ Intermittent: _____ Horsepower _____ RPM _____ Gear Reduction Ratio: _____

Shaft - Other Information

Shaft-Bore Diameter: _____ Full Taper Hub Requested
 Wake Fraction (WF): _____

Current or Previous Propulsion System Information for This Vessel Any existing performance information assists in providing a more accurate propeller suggestion.

Engine Information

Manufacturer: _____ Single: Twin: Triple: Other: Year: _____ Diesel: Gas:
 Engine Rating _____ Shaft: _____ Continuous: _____ Intermittent: _____ Horsepower _____ RPM _____ Gear Reduction Ratio: _____
 Brake: _____ Intermittent: _____ Horsepower _____ RPM _____

Propeller Information

Manufacturer: _____ Model: _____ Diameter: _____ Pitch: _____ Num. blades: _____ Area: _____
 Material: Bronze Stainless Steel NiBrAl Other TE Cup Propeller blade tip to hull clearance: _____
 Notes: _____

Performance

Full Throttle: _____ RPM _____ Speed _____
 Cruise: _____ Vessel Displacement during performance run: _____



Inboard Propeller Warranty Statement

Seller warrants to Buyer that the supplies or articles furnished hereunder shall at time of shipment conform to and be in accordance with the specifications, if any, referred to in this document. Propeller warranty will be considered for any claims against defects in material and workmanship within a period of one year from date of purchase. No claims will be allowed for propellers modified from factory standards. Unless certified by Seller's engineering department, performance expectation shortfall, or incorrect recommendation of propeller size, are not due cause for warranty claim. Seller's obligation under this warranty is limited to Seller's repair or replacement, at Seller's sole discretion, of those goods sold by Seller to Buyer that do not satisfy this warranty. Written notice of the warranty claim must be given to Seller by Buyer within fifteen (15) days after the warranty claim is discovered. Buyer shall obtain R.G.A. number (Return Goods Authorization) and directive of incoming transportation from Seller. Return shipment shall be prepaid at Buyer's expense and shall occur within (10) days after receipt by Buyer of Seller's written authorization. This warranty sets forth Seller's obligations and Buyer's exclusive remedy for defective products.

The determination of whether a defect exists shall be made solely by Seller. Buyer shall not return any goods to Seller until Seller has been provided a reasonable opportunity to inspect and sample the goods to determine whether a valid warranty claim exists and whether the goods should be repaired or replaced. In any event, Buyer shall not return any goods until authorized in writing by Seller.

Notwithstanding any other provision in the document, Seller expressly disclaims and excludes all other warranties, expressed or implied, including the warranties of merchantability and fitness for particular purpose and also disclaims and excludes all liability for incidental, consequential, indirect or any other special damages, including lost profits, for breach of warranty or of contract or otherwise.



World Headquarters
1501 Buchanan Avenue Southwest
Grand Rapids, MI 49507
United States

Toll-Free: 1-800-369-4335
Phone: 1-616-452-6941
Fax: 1-616-247-0227

info@miwheel.com
www.miwheel.com

Europe Headquarters
Unit C1 B, Pottery Road
Newton Abbot, Devon TQ12 3BN
United Kingdom

Phone: +44 1626 351723
Fax: +44 1626 351724

sales@miwheel-europe.com
www.miwheel-europe.com

Middle East • Africa • Asia Headquarters
P.O. Box 54805, DY-1, Show Room No. 7
Al Jadaf Ship Docking Yard, Dubai
United Arab Emirates

Phone: +971 4 3243867
Fax: +971 4 3243868

sales@miwheel-meaa.com
www.miwheel-meaa.com

© 2016 Michigan Wheel Marine
Printed in the USA. July 2016.
All Rights Reserved.

Part Number 99022516